

ZONING BOARD OF REVIEW MEETING

Jamestown Town Hall

Rosamond A. Tefft Council Chambers

93 Narragansett Avenue

Tuesday, July 28, 2020

7:00 PM

PURSUANT TO EXECUTIVE ORDER'S NO. 20-05 & NO. 20-25 EXECUTED BY GOVERNOR GINA RAIMONDO ON MARCH 16, 2020 & APRIL 15, 2020. THIS MEETING WILL BE TELECONFERENCED VIA ZOOM AND VIA TELEPHONE:

The public is invited to observe and participate in the deliberations of this meeting by accessing the meeting link set forth herein. For those without access to video observation platforms, you may also call in to listen and participate in the deliberations of this meeting by using the call in phone number provided herein.

JOIN VIA PHONE: 1(301) -715- 8592 or 1(312) - 626- 6799 or 1(646) - 558- 8656

WHEN PROMPTED, ENTER MEETING ID: 981 1634 7852

PRESS # AGAIN TO JOIN THE MEETING

To participate during Public Hearing or Public Input you will press *9 to raise your hand.

JOIN VIA COMPUTER OR MOBILE APP: <https://zoom.us/j/98116347852>

MEETING ID: 981 1634 7852

To participate during Public Hearing or Public Input, please use the raise your hand icon in the Zoom.

I. ROLL CALL; CALL TO ORDER

II. TELECONFERENCE PROCEDURES FOR PROCEEDINGS & PUBLIC PARTICIPATION

III. APPROVAL OF MINUTES

- A. Approval of the minutes of the June 23, 2020 meeting; discussion and/or action and/or vote.

IV. CORRESPONDENCE

V. NEW BUSINESS

- A. Application of Frances M. Falsey whose property is located at 71 Columbia Ave. and further identified as Assessor's Plat 9, Lot 144 for a variance from Article 3, Section 82-301, Uses & Districts (Table 3-1) to allow an off-site business to utilize the exterior fenced in portion of the property for a Dog Park, which use is not provided for in Table 3-1 and is thereby prohibited under Section 82-301. Said property is located in a R8 zone and contains 13,068 square feet.; review, discussion and/or potential action and/or vote
- B. Application of Gail & David Stokes, whose property is located at 86 Frigate St., and further identified as Assessor's Plat 16, Lot 85 for a variance from Article 3

Table 3.2 District Dimensional Regulations & a special use permit from Article 3 Section 314 High Groundwater Table and Impervious layer District to construct an addition to an existing house. The addition will be 20 ft from the front lot line where 30 ft. is required. The lot is within the High Groundwater District Sub District A and so requires a special use permit to exceed allowable impervious surface. Existing impervious surface will be reduced from 26.5% of the lot to 18.3% in the renovation. Said property is located in a R40 zone and contain 7200 sq. ft ; review, discussion and/or potential action and/or vote

- C. Application of Andrew and Colleen MacIntyre whose property is located at 9 Maple Avenue, and further identified as Assessor's Plat 9, Lot 14 for dimensional relief granted under Article 6, Special Use Permits and Variances, pursuant to Section 82-302, Table 3-2 for the Village Special District Zones R8, R20, CL and CD4, to construct a proposed porch with a front setback of 17 feet where 30 feet is required. The applicant is also seeking relief from Article 7 Section 82-705, Alteration of a nonconforming structure where the subject property currently has a deck that is approximately 19 feet from the front property line were 30 feet is required. Said property is located in a R20 zone and contains approximately 30492 square feet; review, discussion and/or potential action and/or vote
- D. Application of Andrew Bilodeau, whose property is located at Beach Ave & Riptide St., and further identified as Assessor's Plat 5, Lot 164 for a variance/special use permit from Article 3, Section 82-314 High Groundwater Ordinance Sub-District A and Section 82-302-2 Table 3-2 "Setbacks", Article 6, Section 82-601 Section "Special Use Permits" and Sections 82-605 & 82-606 to construct a single family dwelling with a front yard setback of 30' where 40' is required in a High Groundwater Sub-district A.. Said property is located in a R40 zone and contains 21,600 sq. ft.; review, discussion and/or potential action and/or vote

VI. ADJOURNMENT

PLEASE NOTE: All Correspondence or Exhibits you wish the Board to consider on any of the above matters must be received by the Zoning Board Clerk Office no later than Thursday, July 23, 2020. You may submit those documents the following ways: Email to pwestall@jamestownri.net or via drop box located on the West Street side entrance of Town Hall, or by regular mail 93 Narragansett Avenue, Jamestown, RI 02835

The website link for the public to use to watch any meeting in Council Chambers is:
<http://158.123.195.41/OTRMedia/Town2020/Others2020/StreamPrimJtown.html>

Pursuant to RIGL §42-46-5(c) Notice of this meeting shall be posted on the Secretary of State's website and at the Town Hall and the Jamestown Philomenian Library. In addition notice may also be posted at the Jamestown Police Station and on the Internet at www.jamestownri.gov.

This meeting location is accessible to the physically challenged. If communications assistance or other accommodations are needed to ensure equal participation, please call 1-800-745-5555 not less than three (3) business days prior to the meeting.

Posted on the RI Secretary of State website.

JAMESTOWN ZONING BOARD OF REVIEW

Minutes of the June 23, 2020 Meeting

**A regular meeting of the Jamestown Zoning Board of Review was held June 23, 2020.
THIS MEETING Was TELECONFERENCED VIA ZOOM AND VIA TELEPHONE:**

The Chairman called the meeting to order at 7:00 p.m. The Zoning Officer called the roll and noted the following members present:

Richard Boren, Chair
Dean Wagner, Vice-chair
Terence Livingston, Member
Edward Gromada, Member
Marcy Coleman, Member
Judith Bell, 1st Alt.
Erik Brine, 2nd Alt.

Also present: Erin Liese, Town Clerk
Brenda Hanna, Stenographer
Chris Costa, Zoning Officer
Wyatt Brochu, Counsel

MINUTES

Minutes of February 25, 2020

A motion was made by Edward Gromada and seconded by Terence Livingston to accept the minutes of the February 25, 2020 meeting as presented.

The motion carried by a vote of 5 -0.

Richard Boren, Dean Wagner, Terence Livingston, Edward Gromada, and Marcy Coleman voted in favor of the motion.

Judith Bell and Erik Brine were not seated and James King was absent.

CORRESPONDENCE

Nothing at this time.

NEW BUSINESS

Lucier

A motion was made by Dean Wagner and seconded by Marcy Coleman to grant the request of Maria F. and David J. Lucier whose property is located at 10 Coulter Street and further identified as Assessor's Plat 7, Lot 123 to extend a variance granted on February 27, 2019 for an additional **one-year period**. A variance was granted from Article 3, Section 82-302 "District Dimensional Regulations" for setbacks to reconstruct single story portions of an existing structure within the existing footprint, and reconstruct north and south decks with a connecting deck and to construct new stairs. The variance proposed a south side setback of 8'2" and east side setback of 13'4" where 20' is required, and a corner setback of 27'6" where 30' is required. Said property is located in a R40 zone and contains 21,182 square feet.

The motion carried by a vote of 5 -0.

Richard Boren, Dean Wagner, Terence Livingston, Marcy Coleman, and Judith Bell voted in favor of the motion.

Edward Gromada recused himself and Erik Brine was not seated and James King was absent.

Clark B.Y.

A motion was made by Marcy Coleman and seconded by Edward Gromada to grant the request of James Clark, et al/Clark Boat Yard, whose property is located at 120 Racquet Rd., and further identified as Assessor's Plat 9, Lot 328 for a one-year extension of a previously granted special use permit under Article 3, Table 3-1, Marina, Ship & Boat Storage & Repair, Alteration of a Non-conforming Use under Article 7, Section 82-704, Special Use Permits & Variances under Article 6, to remove a 48' x 60' one story section of storage shed & construct a 48' x 60' three story addition on same foot print. Said property is located in a RR80 zone and contains 1.75 acres.

The motion carried by a vote of 5 -0.

Richard Boren, Dean Wagner, Terence Livingston, Edward Gromada, and Marcy Coleman voted in favor of the motion.

Judith Bell and Erik Brine were not seated and James King was absent.

Carlson

A motion was made by Marcy Coleman and seconded by Dean Wagner to continue the request of Donald R. et Laura J. Carlson to the August 25, 2020 meeting to re-advertise due to discrepancies in the advertisement and the application.

The motion carried by a vote of 5 -0.

Richard Boren, Dean Wagner, Terence Livingston, Edward Gromada, and Marcy Coleman voted in favor of the motion.

Judith Bell and Erik Brine were not seated and James King was absent.

Please note: James King, 3rd Alt. joined at 7:20.

Keiser

A motion was made by Marcy Coleman and seconded by Terence Livingston to grant the request of Bruce R. Keiser, whose property is located at 1021 East Shore Rd., and further identified as Assessor's Plat 1, Lot 165 for a variance from Article 3, Section 82.302 Table 3-2, District Dimensional Regulations, & Article 6, Section 82-605 Variances to construct a shed 4' from property line where 20' is required.

This Board has determined that this application does satisfy the requirements of ARTICLE 6, SECTION 600, SECTION 606, and SECTION 607, PARAGRAPH 2.

This Variance is granted with the following restriction/condition(s):

This project must be constructed in strict accordance with the site and building plans duly approved by this Board.

This motion is based on the following findings of fact:

1. Said property is located in a R80 zone and contains 5,000 sq. ft.
2. The pre-existing non-conforming lot is unique as it is extremely small in comparison to other lots in the area.
3. Dimensional relief is needed due to the unique characteristics of the lot.
4. The existing house is built on a slab and there is minimal storage space available to the homeowner.
5. There is a 6-foot cedar fence along the north and west property borders.
6. The proposed shed, which is only 6 x 10 in footprint area and 8' 8 3/4" high, will be substantially hidden by the 6 ft. fence on the north side.
7. The shed could not be placed on the west side of the house as a patio has been installed in that area.
8. Abutters to the north & west objected to the variance request and prefer that the shed be built in the area of the existing patio.

The motion carried by a vote of 5 -0.

Richard Boren, Dean Wagner, Terence Livingston, Edward Gromada, and Marcy Coleman voted in favor of the motion.

Judith Bell, Erik Brine, and James King were not seated.

ADJOURNMENT

A motion was made and seconded to adjourn at 8:05 p.m.
The motion carried unanimously.



Town of Jamestown, Rhode Island

Web GIS Maps and Online Property Information

by MainStreetGIS, LLC. Town Website

[User Guide](#) [Feedback](#) [Disclaimer](#)

v1.13g

Base Map:

Address Parcel ID Owner

GIS Map Street View Tax Maps Other Maps



[Layers](#) [Property](#) [Selection](#)

71 COLUMBIA AVENUE

9-144



- [Zoom To](#)
- [Property Card](#)
- [Abutters List](#)
- [Tax Map](#)
- [Property List](#)
- [Report an Issue](#)

1 : [1693]



Parcel ID: 9-130
PAZERA, KATHY G.
57 COLUMBIA AVENUE
JAMESTOWN RI 02835

Parcel ID: 9-131
JONES, ALFRED H. JR, TRUST &
MARYE-VATES F. JONES TRUST TIC
2050 SOUTHWEST 10TH COURT
DELRAY FL 33445

Parcel ID: 9-137
ROTHROCK, MARTIN & BETH
717 BRACEY LANE
ALEXANDRIA VA 22314

Parcel ID: 9-138
BAKER, STEPHEN C ET
BAKER, GLONE J S
73 COLUMBIA AVENUE
JAMESTOWN, RI 02835-1344

Parcel ID: 9-140
BRINE, ERIK G ET UX
BRINE KERRY E TE
83 COLUMBIA AVENUE
JAMESTOWN RI 02835

Parcel ID: 9-142
LUNDY, BARBARA
38 SOUTHWEST AVENUE
JAMESTOWN RI 02835

Parcel ID: 9-143
WALKER, DAVID J
80 COLE STREET
JAMESTOWN RI 02835

Parcel ID: 9-144
FALSEY, FRANCES M
71 COLUMBIA AVE
JAMESTOWN RI 02835

Parcel ID: 9-145
SREG MANAGEMENT LLC
C/O CRIS CRECELUS
95 SOCKNOSET CROSSROAD STE 203
CRANSTON RI 02920

Parcel ID: 9-146
ESTES, KAREN L.
P.O. BOX 508
JAMESTOWN RI 02835-0508

Parcel ID: 9-147
MESSINGER, NORMAN F & KAREN E
77 COLE STREET
JAMESTOWN, RI 02835

Parcel ID: 9-148
MUELLER, CORNELIA A ET
MUNNS, WAYNE R JR
73 COLE STREET
JAMESTOWN, RI 02835

Parcel ID: 9-149
MOORE, EMILY
67 COLE STREET
JAMESTOWN RI 02835

Parcel ID: 9-150
SORLIEN, SANDRA ET
ARNOLD, JOHN HENRY TE
82 HOWLAND AVENUE
JAMESTOWN RI 02835

Parcel ID: 9-151
CROWLEY, TANYA V ET
CROWLEY, RAMOND V.
88 HOWLAND AVENUE
JAMESTOWN RI 02835

Parcel ID: 9-152
TOWN OF JAMESTOWN
93 NARRAGANSETT AVENUE
JAMESTOWN RI 02835

Parcel ID: 9-154
NOTA, ANDREW E & MICHELE A
61 COLE STREET
JAMESTOWN RI 02835

Parcel ID: 9-374
GORTON, EUNICE M (EST OF) ET
RAWSON, JANEEN
225 COLLINS-TAFT RD.
HARRISVILLE, RI 02830

Parcel ID: 9-379
JOYCE, MARY ANN
90 HOWLAND AVE
JAMESTOWN RI 02835

Parcel ID: 9-657
DENNEN, GEORGIA
73 CLARKE STREET
JAMESTOWN RI 02835

Parcel ID: 9-80
DIGIANDO, JULIO, TRUSTEE
63 CLARKE STREET
JAMESTOWN RI 02835

Parcel ID: 9-82
DIGIANDO, JULIO, TRUSTEE
63 CLARKE STREET
JAMESTOWN, RI 02835

Parcel ID: 9-83
TEMPLETON-COTILL, ANNA, TRUSTEE
59 CLARKE STREET
JAMESTOWN RI 02835

Parcel ID: 9-84
KATZ, JEFFREY R ET
O'CONNOR, THERESA
66 COLUMBIA AVENUE
JAMESTOWN RI 02835

Parcel ID: 9-86
MOLLOY, VALERIE
70 COLUMBIA AVE
JAMESTOWN, RI 02835

Parcel ID: 9-864
HAMON, KARI A ET
BURKE, SARAH TE
85 COLE STREET
JAMESTOWN RI 02835

Parcel ID: 9-87
RUGGIERO, DEBORAH ET
IOANES, BARBARA JEAN ET
78 COLUMBIA AVENUE
JAMESTOWN RI 02835

30
 + 680

 204.00
 + 200.00 app

 404.00
 Cash

TOWN OF JAMESTOWN
ZONING BOARD OF REVIEW

RECEIVED
6-10-20
Costa

Application for Exception or Variation under the Zoning Ordinance

Zoning Board of Review;

Jamestown, R. I.

Date JUNE, 2020

Gentlemen:

The undersigned hereby applies to the Zoning Board of Review for an exception or a variation in the application of the provisions or regulations of the zoning ordinance affecting the following described premises in the manner and on the grounds hereinafter set forth.

Applicant FRANCES M. FALSEY Address 71 COLUMBIA AVENUE, JAMESTOWN, RI

Owner SAME Address _____

Lessee N/A Address _____

1. Location of premises: No. 71 COLUMBIA AVENUE ~~Street~~

2. Assessor's Plat 9 Lot 144

3. Dimensions of lot: frontage 60 ft. depth 220 ft. Area 13,068 sq. ft.

4. Zoning Districts in which premises are located: Use R8 Area _____ Height _____

5. How long have you owned above premises? 17 YEARS

6. Is there a building on the premises at present? YES

7. Size of existing building 784 SQ. FT

Size of proposed building or alteration N/A

8. Distance of proposed bldg. or alteration from lot lines:

front _____ rear _____ left side _____ right side _____

9. Present use of premises: RESIDENTIAL

10. Proposed use of premises: RESIDENTIAL AND DOG PARK FOR INCIDENTAL OFF-SITE BUSINESS USE

Location of septic tank & well on lot N/A

11. Give extent of proposed alterations NO ALTERATIONS TO THE PROPERTY WILL BE MADE

12. Number of families for which building is to be arranged: N/A

13. Have you submitted plans for above to Inspector of Buildings? _____

Has the Inspector of Buildings refused a permit? YES

14. Provision or regulation of Zoning Ordinance or State Enabling Act under which application for exception or variance is made:

ARTICLE 3 SECTION 82-301 AND TABLE 3-1

15. State the grounds for exception or variation in this case:

THE APPLICANT HAS PERMITTED OCCASIONAL USE OF HER PROPERTY FOR A FRIEND'S DOG CARE BUSINESS TO ALLOW A LIMITED NUMBER OF DOGS TO HAVE SUPERVISED "PLAY" IN THE YARD OF THE SUBJECT PROPERTY. THE UNIQUE NATURE OF THE PROPERTY (I.E. FENCED YARD IN TOWN) ALLOWS FOR THIS USE WITHOUT HARM TO THE ANIMALS OR TRESPASS

UPON ANY NEIGHBORING PROPERTY. THE APPLICANT WILL NOT REALIZE ANY FINANCIAL GAIN FROM THE GRANTING OF THE VARIANCE AS THE APPLICANT IS NOT PAID IN ANY MANNER BY THE BUSINESS OWNER AND APPLICANT DOES NOT OWN A PET. THE GRANTING OF THE VARIANCE WILL NOT ALTER THE GENERAL CHARACTER OF THE SURROUNDING AREA.

Respectfully Submitted,

Signature Francis M. Falvey

Address 71 COLUMBIA AVENUE

JAMESTOWN, RI 02835

Telephone No. 401-965-385

NOTE: A LOCATION PLAN AND SKETCH AND DRAWINGS NECESSARY TO GIVE FULL INFORMATION MUST BE FILED WITH THE APPLICATION.

RICHARD BOREN, CHAIRMAN
CHRIS COSTA, ZONING OFFICER

CORRESPONDENCE
received

7-14-20

59 Clarke St.
Jamestown
RI 02835

For the Zoning Board -

As a local resident I can
confirm that the Dog Park
has never been noisy or a
problem in any way to the
residents of this part of
Jamestown. The dogs are
not noisy and there are
not too many of them as
any one time.

I suggest the need owners
wait a while and see how it
goes -

Anne Templeton-Cotter

SAMPLE ZONING ADVERTISEMENT
MUST BE FILLED OUT BY THE APPLICANT

RECEIVED
6-10-20
Costa

Application of FRANCES M. FALSEY whose

property is located at 71 COLUMBIA AVENUE, and further

identified as Tax Assessor's Plat 9, Lot 144 for a Variance/~~Special Use Permit~~

from Article 3, Section 82-301, USES AND DISTRICTS (TABLE 3-1)

to ALLOW AN OFF-SITE BUSINESS TO UTILIZE THE EXTERIOR FENCED IN PORTION OF THE PROPERTY

FOR A DOG PARK, WHICH USE IS NOT PROVIDED FOR IN TABLE 3-1 AND IS THEREBY PROHIBITED

UNDER SECTION 82-301.

Said property is located in a R8 zone and contains 13,068 ~~acres~~/square feet.

.....
HOW TO WRITE YOUR AD:

Name of owner must be advertised exactly as it appears on the most recent deed for the property. If the applicant's name differs from the owner, the ad must read: "Application of John R. Smith et ux Mary, (Jane L. Doe, owner), whose property...etc." The exact street address must be included in the advertisement, as well as the Tax Assessor's Plat and Lot numbers. Cross out "Variance" or "Special Use Permit" if one does not apply to what you are seeking. List the exact Article(s) and Section(s) numbers from the Zoning Ordinance from which you are seeking relief, followed by the title of the section as it appears in the Ordinance. Then briefly describe what you wish to do: "to construct a tool shed five feet from the side lot line instead of the required ten feet". List what zone your property is in: R8, R20, R40, RR80, RR200, CL, CD, CW or OS. Finally, enter the total acreage or square footage of your lot, crossing out the term that does not apply: acres or square feet.

RECEIVED
7-14-20

**TOWN OF JAMESTOWN
ZONING BOARD OF REVIEW
NOTICE OF PUBLIC HEARING
Tuesday, July 28, 2020
7:00 PM**

PURSUANT TO EXECUTIVE ORDER'S NO. 20-05 & NO. 20-25 EXECUTED BY GOVERNOR GINA RAIMONDO ON MARCH 16, 2020 & APRIL 15, 2020. THIS MEETING WILL BE TELECONFERENCED VIA ZOOM AND VIA TELEPHONE:

The public is invited to observe and participate in the deliberations of this meeting by accessing the meeting link set forth herein. For those without access to video observation platforms, you may also call in to listen and participate in the deliberations of this meeting by using the call-in phone number provided herein.

**JOIN VIA PHONE: 1(301) -715- 8592 or 1(312) - 626- 6799 or 1(646) - 558- 8656
WHEN PROMPTED, ENTER MEETING ID: 981 1634 7852
PRESS # AGAIN TO JOIN THE MEETING
To participate during Public Hearing or Public Input you will press *9 to raise your hand.**

**JOIN VIA COMPUTER OR MOBILE APP: <https://zoom.us/j/98116347852>
MEETING ID: 981 1634 7852
To participate during Public Hearing or Public Input, please use the raise your hand icon in the Zoom.**

On the following matter:

Application of Frances M. Falsey whose property is located at 71 Columbia Ave. and further identified as Assessor's Plat 9, Lot 144 for a variance from Article 3, Section 82-301, Uses & Districts (Table 3-1) to allow an off-site business to utilize the exterior fenced in portion of the property for a Dog Park, which use is not provided for in Table 3-1 and is thereby prohibited under Section 82-301. Said property is located in a R8 zone and contains 13,068 square feet.

PLEASE NOTE: All Correspondence or Exhibits you wish the Board to consider on any of the above matters must be received by the Zoning Board Clerk Office no later than Thursday, July 23, 2020. You may submit those documents the following ways: Email to pwestall@jamestownri.net or via drop box located on the West Street side entrance of Town Hall, or by regular mail 93 Narragansett Avenue, Jamestown, RI 02835.

Please find website link for Meeting Material, Notice of Applications, Exhibits, and Correspondence: <http://www.jamestownri.gov/home/showdocument?id=57559>

This meeting location is accessible to the physically challenged. Hearing or speech impaired individuals requiring the services of an interpreter should call 1-800-745-5555 not less than 3 business days prior to the meeting.

*Georgia Dennen owner of 2 properties
73 CLarke St.*

**BY ORDER OF THE
ZONING BOARD OF REVIEW**

I do object to this as a property owner of 82 Columbia Ave and there is enough dog walkers & dog barking in these areas of my homes. people dont pick up after there dog waste. This is a residential area for us. Children playing and walking riding bikes. We dont need a dog park in this area

73 Clarke Street here

McQuades parking lot + store

Archer & Foppert, LLP

57 Narragansett Avenue, Jamestown, RI 02835
Fax: 401.423.9700

Deborah A. Foppert, Esq.
Deb.Foppert@gmail.com
Direct: (401) 423-2329

RECEIVED
6-10-20
Costa

June 9, 2020

Chris Costa, Zoning Officer
Town of Jamestown
93 Narragansett Avenue
Jamestown, Rhode Island 02835

Re: 71 Columbia Avenue

Dear Chris,

Enclosed please find an Application for Variation under the Zoning Ordinance and the Sample Zoning Advertisement. I understand from Christine Brochu that your office is determining the abutters list at this point. Once you and Pat know the amount of the full filing fee, please let me know and I will have the applicant drop off a check. Likewise, I know your schedule is in flux, but please let me know once the meeting is scheduled.

Thanks,



Deb

TOWN OF JAMESTOWN
ZONING BOARD OF REVIEW

Application for Exception or Variation under the Zoning Ordinance

Zoning Board of Review;

Jamestown, R. I.

Date JUNE 17, 2020

Gentlemen:

The undersigned hereby applies to the Zoning Board of Review for an exception or a variation in the application of the provisions or regulations of the zoning ordinance affecting the following described premises in the manner and on the grounds hereinafter set forth.

Applicant DAVID & GAIL SIDRES Address 86 FRIGATE ST

Owner SAME Address _____

Lessee _____ Address _____

1. Location of premises: No. 86 FRIGATE ST Street

2. Assessor's Plat 16 Lot 85

3. Dimensions of lot: frontage 120 ft. depth 60 ft. Area 7200 sq. ft.

4. Zoning Districts in which premises are located: Use R 40 Area 20,000 Height 35
R 20 ZONING APPLIES

5. How long have you owned above premises? SINCE JANUARY 2020

6. Is there a building on the premises at present? YES
24 x 32 = 768 SQ FT & 19 SQ FT

7. Size of existing building 787 SQ FT
HABITABLE STRUCTURE 344 SQ FT
Size of proposed building or alteration FRONT COVERED PORCH 22 SQ FT
TOTAL OF EXISTING AND ADDITION 1153 SQ FT.

8. Distance of proposed bldg. or alteration from lot lines:

EXISTING HOUSE front 16 rear 9 left side 63 right side 29
PROPOSED ADDITION 20 12 87 15

9. Present use of premises: SINGLE FAMILY HOME

10. Proposed use of premises: SAME

Location of septic tank & well on lot YES SEE PRINCIPLE
SOIL PLAN.

11. Give extent of proposed alterations RENOVATION & ADDITION THAT ENLARGES BEDROOM & BATH, CREATES A DINING AREA, MUDROOM & COVERED ENTRY PORCH. HOUSE WILL BECOME MORE EASILY ACCESSIBLE AND WILL PROVIDE MORE ACCESSIBLE STORAGE & LIVING AREA

12. Number of families for which building is to be arranged: ONE

13. Have you submitted plans for above to Inspector of Buildings? YES

Has the Inspector of Buildings refused a permit? YES

14. Provision or regulation of Zoning Ordinance or State Enabling Act under which application for exception or variance is made:

Article 6, section 601 of the Jamestown Zoning Ordinance empowers the Jamestown Zoning Board of Review to grant a special use permit as per the requirements of Article 3, Section 314 High Groundwater table and impervious layer district. Article 6, Section 606 Empowers the Zoning board to grant a variance from Article 3, Table 3.2 District Dimensional Regulations that requires a residential primary structure to be located 30 feet from the front lot line. With the existing house only 16 feet from the front lot line, the proposed addition is located 20 feet from the front lot line instead of the required 30.

15. State the grounds for exception or variation in this case:

SEE ATTACHED

Respectfully Submitted,

Signature JE Stokes

Address 86 Frigate St
Jamestown, RI

Telephone No. 401 ~~888~~ 323-6620

NOTE: A LOCATION PLAN AND SKETCH AND DRAWINGS NECESSARY TO GIVE FULL INFORMATION MUST BE FILED WITH THE APPLICATION.

15 State grounds for exception or variation in this case:

We propose to construct an addition to 86 Frigate Street that will enable us to more appropriately and fully enjoy our property. We have lived in this house for six years as tenants and finally bought it in January of this year. The existing house footprint is 787 square feet. While there is some living space on the lower, basement floor, David Stokes has cerebral palsy and getting up and down a steep set of stairs is perilous. And so almost all our activities occur on a first floor that is woefully small.

We propose to reconfigure and add to the existing structure so that the bedroom and bathroom are larger and more functional. There will be a small study on the first floor, a necessity for the professor and librarian that we, respectively, are. There will be more storage that is also more easily accessible. The kitchen will actually be smaller, but in reorganizing and adding to the space, we were able to create a dining area as well as a mud room with a closet, neither of which exist in the current house. There will also be a small covered entry porch, which also does not exist in the current structure. These changes will make the house much easier for us to live in especially as we age.

Though we are proposing an addition to the building footprint, we will reduce the impervious coverage on this lot from 1908 square feet to 1315.8 square feet. This eliminates more than 30% of the current impervious coverage, *after* the construction of the addition, a remarkable improvement for this typical Jamestown Shores lot. Even with such a reduction, it still exceeds the limit of impervious lot coverage for a lot in sub district A of the Groundwater district. Hence our application for a Special Use Permit as per the requirements of Section 314 of the Zoning Ordinance. Town Environmental Engineer, Jean Lambert, recommended to the Planning Commission to approve our application for a Special Use Permit, and at its meeting on June 17, 2020, the Planning Commission voted to recommend that the Zoning Board of Review should grant us a Special Use Permit.

The existing house was built in 1970 and was located only 16 feet from the front lot line at Frigate Street instead of the required 30 feet. For this reason, we also need a dimensional variance from the Zoning Board, as per Section 3 table 302 of the Zoning Ordinance, in addition to the Special Use Permit described above. Our addition will be 20 feet from the Frigate Street lot line, or four feet further back from the front lot line than the existing house. We made the addition as small as possible to ensure that it was as far from the front lot line as possible. It is a modest addition to a modest house. But it will improve our lives immeasurably.

We believe the elimination of over 600 feet of impervious surface is a great improvement for the neighborhood. By removing the lower asphalt driveway, we are also removing a significant catchment area for downhill runoff from the steep Frigate St. incline, which was difficult for pedestrians to traverse. The total footprint of the proposed house and addition is 1131 square feet plus a small 22 square foot entry porch. It will not be a big house. We believe the addition, with its front stoop, will enhance the cottage like character of our home, a quality that used to prevail in the Jamestown Shores. We believe our request, for a Special Use Permit and a variance from District Dimensional Regulations, indeed represents "the least relief necessary" that will allow us to enjoy our home as we grow older.

SAMPLE ZONING ADVERTISEMENT
MUST BE FILLED OUT BY THE APPLICANT

Application of GAIL & DAVID STOKES whose

property is located at 86 FRIGATE STREET, and further

identified as Tax Assessor's Plat 16, Lot 85 for a Variance/Special Use Permit

VARIANCE: FROM ARTICLE 3 TABLE 3.2 DISTRICT DIMENSIONAL REGULATIONS

from Article 3, Section 314; HIGH GROUND WATER TABLE AND IMPERVIOUS LAYER DISTRICT

SPECIAL
USE PERMIT:

CONSTRUCT AN ADDITION TO AN EXISTING HOUSE. THE ADDITION
to WILL BE 20 FEET FROM THE FRONT LOT LINE WHERE 30 FEET
IS REQUIRED. THE LOT IS WITHIN THE HIGH GROUND WATER
DISTRICT SUB DISTRICT A AND SO REQUIRES A SPECIAL USE PERMIT.

TO EXCEED ALLOWABLE IMPERVIOUS SURFACE. EXISTING IMPERVIOUS
SURFACE WILL BE REDUCED FROM 26.5% OF THE LOT TO 18.3%
IN THE RENOVATION.

Said property is located in a R40 zone and contains 7200 acres/square feet.

.....

HOW TO WRITE YOUR AD:

Name of owner must be advertised exactly as it appears on the most recent deed for the property. If the applicant's name differs from the owner, the ad must read: "Application of John R. Smith et ux Mary, (Jane L. Doe, owner), whose property...etc." The exact street address must be included in the advertisement, as well as the Tax Assessor's Plat and Lot numbers. Cross out "Variance" or "Special Use Permit" if one does not apply to what you are seeking. List the exact Article(s) and Section(s) numbers from the Zoning Ordinance from which you are seeking relief, followed by the title of the section as it appears in the Ordinance. Then briefly describe what you wish to do: "to construct a tool shed five feet from the side lot line instead of the required ten feet". List what zone your property is in: R8, R20, R40, RR80, RR200, CL, CD, CW or OS. Finally, enter the total acreage or square footage of your lot, crossing out the term that does not apply: acres or square feet.

NOTE THIS SITE PLAN IS TAKEN FROM A SITE PLAN (ALSO INCLUDED IN THIS PACKET) BY PRINCIPLE ENGINEERING AND A SURVEY BY JOHN BARKER, R.L.S.

AP 16 LOT

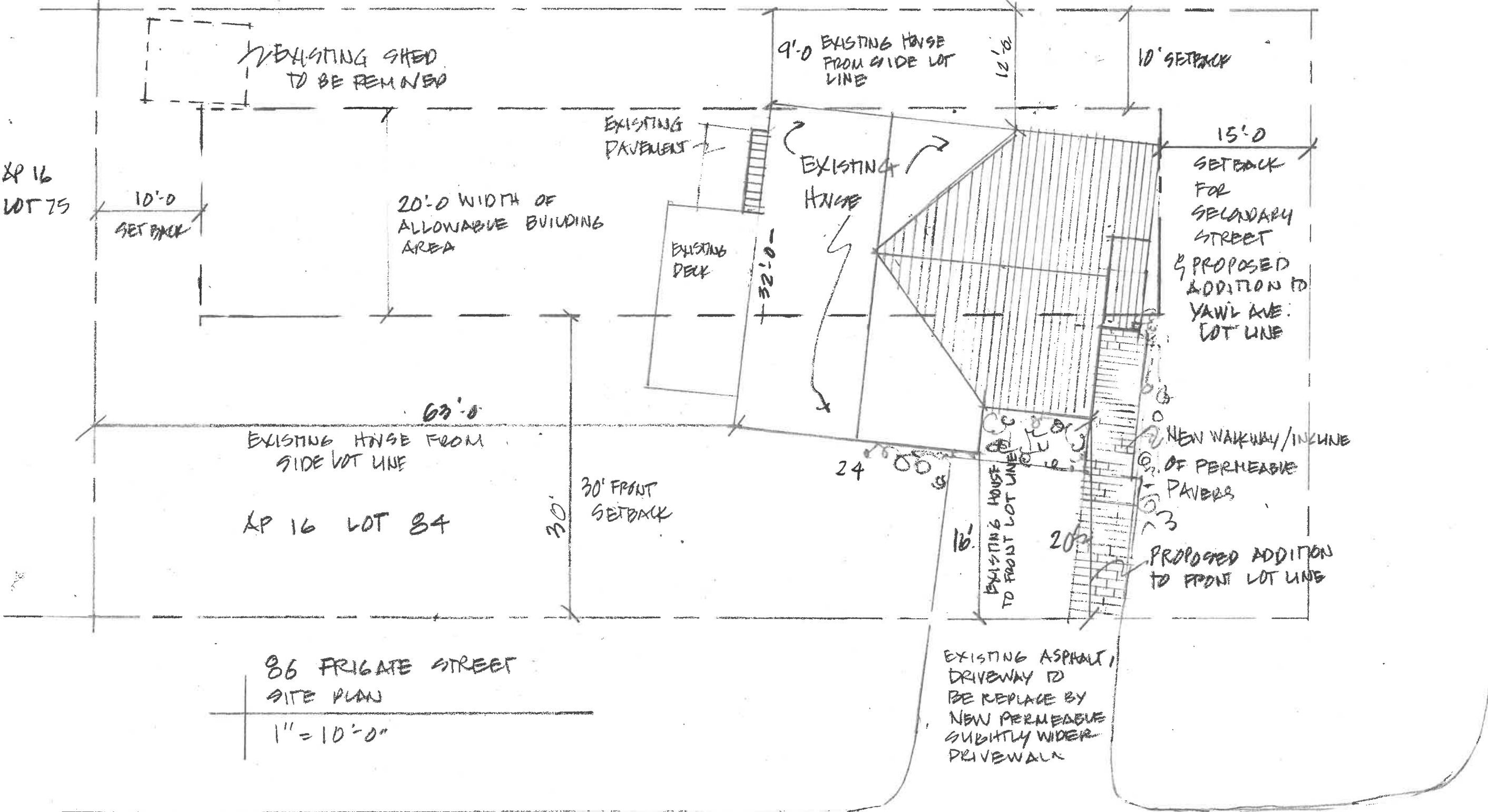

86 FRIGATE STREET
 SITE PLAN
 1" = 10'-0"

F R I G A T E S T R E E T

Y A W L A V E N U E

S.P. 1	PROPOSED ADDITION & RENOVATION 86 FRIGATE ST AP 16 LOT 85	FOR DAVID & GAIL STOKES	SITE PLAN 1" = 10'-0"	JUNE 12, 2020
--------	---	----------------------------	--------------------------	---------------

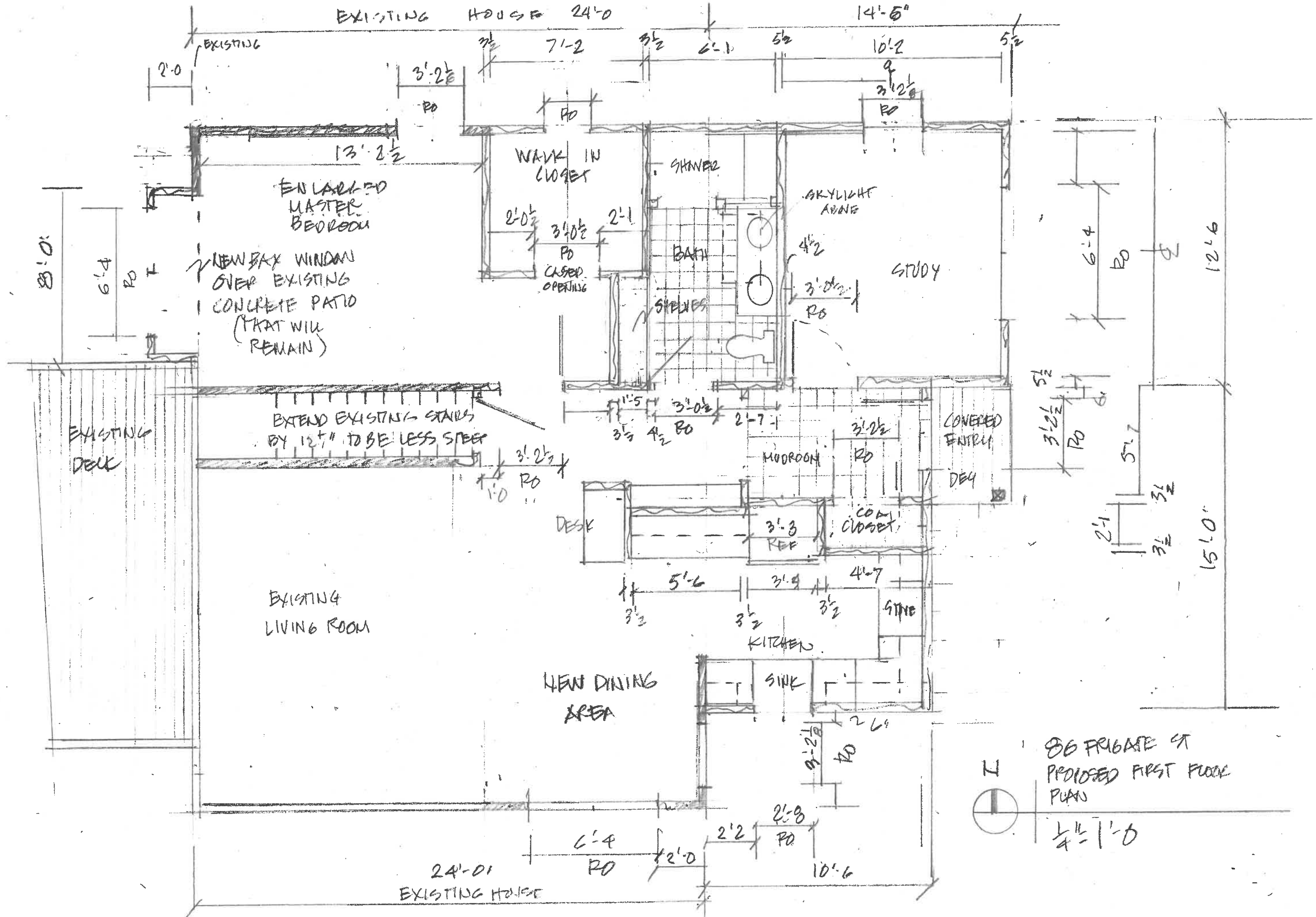

A ↓
 PROPOSED ADDITION & RENOVATION TO 80 FRIGATE ST
 FOR GAIL & DAVID SIDGES FIRST FLOOR PLAN
 JUNE 12, 2000
 AP 16 LOT 25

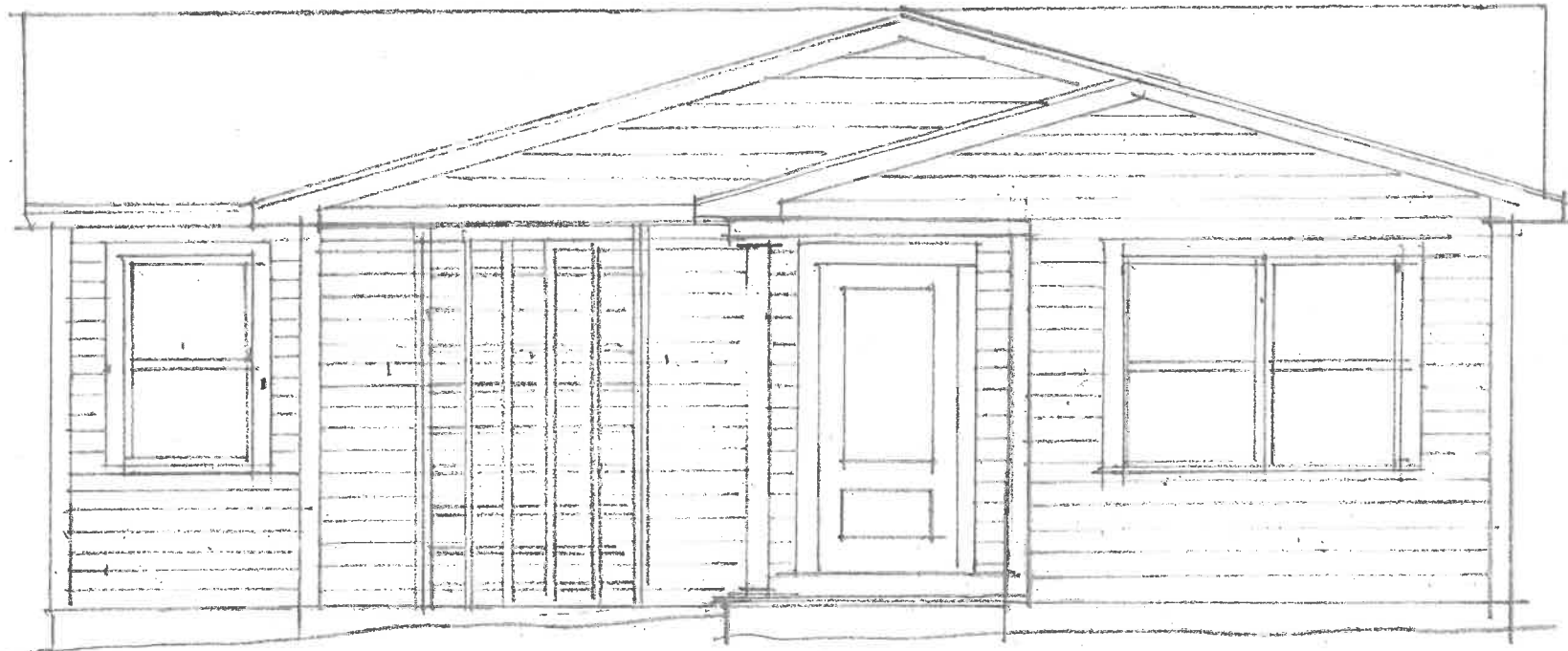

ABOVE
YAWL AVENUE ELEVATION
 $\frac{1}{4}'' = 1'-0''$

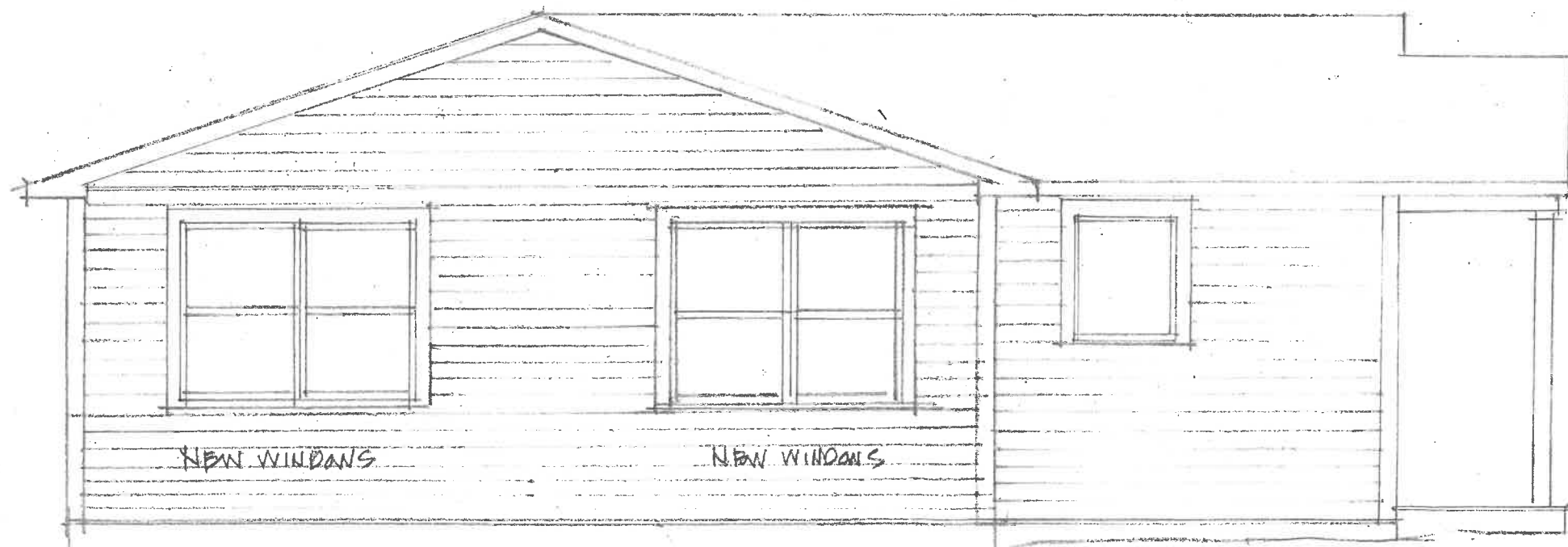

EXISTING HOUSE

ADDITION

FRIGATE STREET ELEVATION
 $\frac{1}{4}'' = 1'-0''$

JUNE 12, 2020

YAWL ST ELEVATION
FRIGATE ST ELEVATION

FOR STALL & DAVID
STUBBS

PROPOSED ADDITION AND
RENOVATION TO
86 FRIGATE STREET

A2

LEGEND & ABBREVIATIONS

INF	- NOW OR FORMERLY	---	- PROPERTY LINE
A.P.	- ASSESSORS PLAT	---	- ZONING SETBACK LINE
S.F.	- SQUARE FEET	---	- EXISTING CONTOUR
AC	- ACRES	---	- FENCE
±	- PLUS OR MINUS	---	- SEWER LINE
STY	- STORY	---	- DRAIN LINE
WF	- WOOD FRAMED	---	- WATER LINE
SHP	- STATE HIGHWAY PLAT	---	- GAS LINE
RET.	- RETAINING WALL	---	- ELECTRIC LINE
FED.	- PEDESTRIAN	---	- SANITARY SEWER MANHOLE
(FND.)	- FOUND	---	- CATCH BASIN
RHS	- RI HIGHWAY BOUND	---	- STORM DRAIN MANHOLE
M.N.	- MASONRY NAIL	---	- WATER GATE
FE	- FLARED END	---	- GAS VALVE
RCP	- REINFORCED CONCRETE PIPE	---	- ELECTRIC MANHOLE
CLP	- CHAIN LINK FENCE	---	- GRANITE BOUND
INV.	- INVERT	---	- DRILL HOLE
SG	- EXISTING SPOT GRADE	---	- IRON PIPE
SW	- EXISTING STONE WALL	---	- PROPOSED LOT LINE
		---	- PROPOSED EASEMENT
		---	- PROPOSED WATER LINE
		---	- PROPOSED SEWER LINE
		---	- PROPOSED GAS LINE
		---	- PROPOSED EDGE OF PAVEMENT
		---	- PROPOSED DOWNSPOUTS

SITE PLAN GRAPHIC SCALE

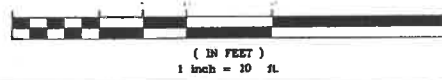

EXISTING

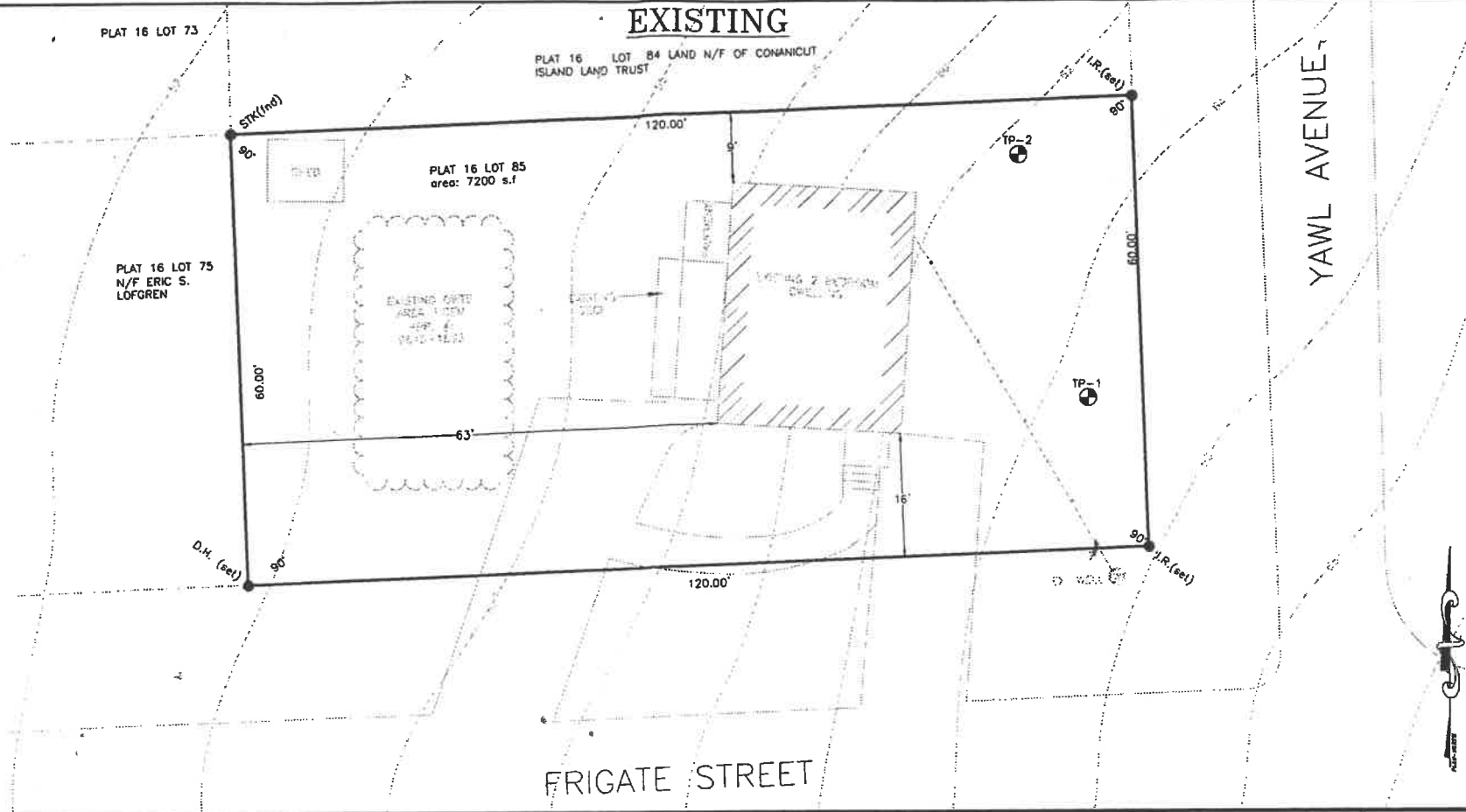

PROPOSED

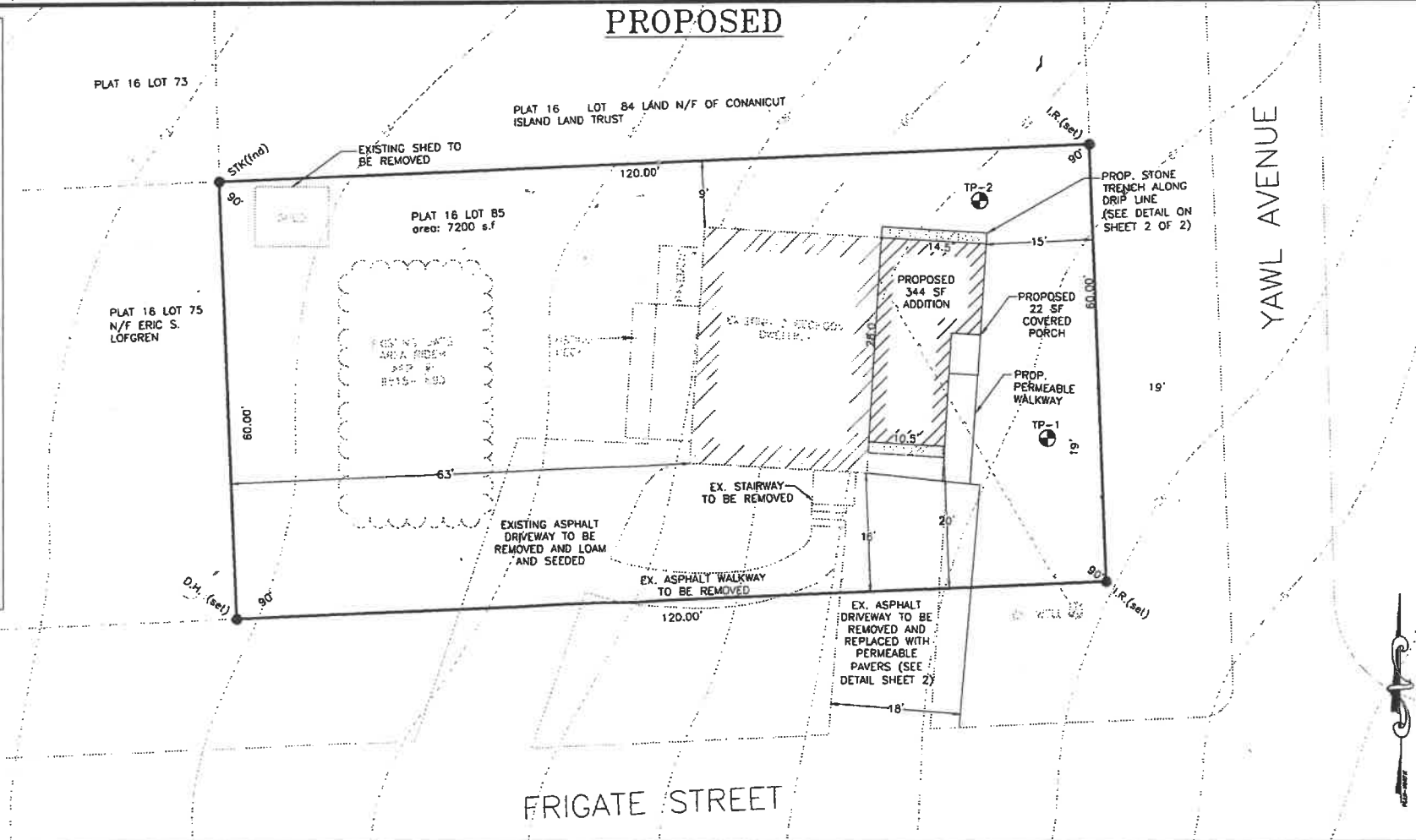

SITE PLAN GRAPHIC SCALE

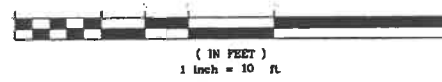

SITE LOCUS
NOT TO SCALE

R-40 ZONING*	EXISTING DIMENSIONS	PROPOSED DIMENSIONS
MAX LOT AREA = 20,000 S.F.	LOT AREA = 7,200 S.F.	LOT AREA = 7,200 S.F.
FRONT YARD = 30 FT.	FRONT YARD = 16 FT.	FRONT YARD = 16 FT. / 15 FT.
REAR YARD = 30 FT.	REAR YARD = 9 FT.	REAR YARD = 9 FT.
SIDE YARD = 10 FT.	SIDE YARD = 28 FT. / 63 FT.	SIDE YARD = 63 FT.
LOT COVERAGE = 10%	LOT COVERAGE = 26.5%	LOT COVERAGE = 18.5%

1. LOT AREA LESS THAN 20,000 SF, THEREFORE R-20 ZONING MAY BE USED
2. LOT FALLS WITHIN HIGH GROUNDWATER TABLE & IMPERVIOUS OVERLAY DISTRICT THEREFORE THE MAX LOT COVERAGE IS 10% - SUB DISTRICT A SEE SOIL LOG.
3. THE SUBJECT LOT IS A CORNER LOT THEREFORE THE SETBACK OFF OF YAWL AVE. IS CONSIDERED A SECONDARY FRONT YARD SETBACK (15')

SOILS:

- TP-1: HTM AT 84"
- TP-2: HTM AT 84"

LOT COVERAGE:

EXISTING HOUSE FOOTPRINT= 787 S.F.
 PROPOSED HOUSE ADDITION FOOTPRINT= 344 S.F.
 PROPOSED COVERED PORCH= 22 S.F.
 EXISTING DRIVEWAY= 656.5 S.F. (TO BE REMOVED)
 EXISTING PAVED AREA= 162.8 S.F.
 EXISTING SHED= 82.6 S.F. (TO BE REMOVED)
 EXISTING WALKWAY= 219.3 S.F. (TO BE REMOVED)

TOTAL EXISTING COVERAGE= 1,908 S.F. / 7,200 S.F. = 0.265 x 100% = 26.5%
 26.5% > 10% ALLOWABLE

EXISTING STRUCTURAL LOT COVERAGE= 869.6 S.F. / 7,200 S.F. x 100% = 12.08%

PROPOSED LOT COVERAGE= 1,315.8 S.F. / 7,200 S.F. = 0.1828 x 100% = 18.3%

PROPOSED STRUCTURAL LOT COVERAGE= 1,153 S.F. / 7,200 S.F. = 0.160 x 100% = 16.0%

CHANGE IN LOT COVERAGE= 18.3% - 26.5% = -8.2%

PLAN REFERENCE:

REFERENCE IS MADE TO THE FOLLOWING MAPS AND PLANS OF RECORD:

PLAN ENTITLED: "SURVEY PLAN FOR GAIL & DAVID STOKES PLAT 16 LOT 85 JAMESTOWN, RI"
 BY: JOHN J. BARKER, PLS

ANY DISCREPANCIES SHALL BE REPORTED TO THE ENGINEER

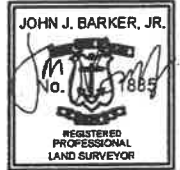

STATE OF RHODE ISLAND AND PROVIDENCE PLANTATIONS
 Department of Environmental Management
 Office of Water Resources

Site Evaluation Form
 Part A - Soil Profile Description Application Number

Property Owner: [Blank]
 Property Location: [Blank]
 Date of Test Hole: [Blank]
 Soil Evaluator: [Blank]

HTM 1 & 2	Depth	Soil Type	Moisture	Texture	Structure	Consistence	Color	Remarks
HTM	84"-0"							
Cr	0"							

Soil Class: [Blank]
 Depth to Groundwater Surface: [Blank]
 Estimated Seasonal High Water Table: [Blank]

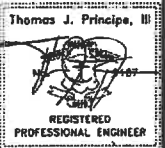

PRINCIPLE COMPANY, INC.
 ENGINEERING DIVISION
 PO BOX 398
 TIVERTON, RI 02878
 401.818.5385
 PRINCIPENGINEERING@GMAIL.COM

REVISIONS

No.	DATE	BY	CHKD
1	5/8/2020	JT	TJP
2	5/14/2020	JT	TJP
3	6/19/2020	JT	TJP

SITE PLAN
 for
AP 16 LOT 85
86 FRIGATE STREET
 in
JAMESTOWN, RHODE ISLAND

SCALE: AS NOTED SHEET NO: 1 OF 2
 DRAWN BY: TJP DESIGN BY: TJP CHECKED BY: TJP
 DATE: 3/19/20 PROJECT NO: ERSC-2020-3



Town of Jamestown, Rhode Island

Web GIS Maps and Online Property Information

by MainStreetGIS, LLC [Town Website](#)

[User Guide](#) [Feedback](#) [Disclaimer](#)

v1.14 - New Features

Base Map:

GIS Map

Street View

Tax Maps

Other Maps

Download

GIS Links

1 : 1693

Layers

Property

Selection

Clear

Save

Mail

Print

Selected: 24

- 15-20 26 SPANKER STREET
- 15-22 20 SPANKER STREET
- 16-102 11 GONDOLA AVENUE
- 16-105 72 FRIGATE STREET
- 16-206 75 FRIGATE STREET
- 16-207 77 FRIGATE STREET
- 16-208 81 FRIGATE STREET
- 16-209 FRIGATE STREET
- 16-210 85 FRIGATE STREET
- 16-211 89 FRIGATE STREET
- 16-214 209 BEACON AVENUE
- 16-63 223 BEACON AVENUE
- 16-65 100 FRIGATE STREET
- 16-71 228 BEACON AVENUE
- 16-73 222 BEACON AVENUE
- 16-75 BEACON AVENUE
- 16-81 15 YAWL AVENUE
- 16-82 11 YAWL AVENUE
- 16-84 YAWL AVENUE
- 16-85 86 FRIGATE STREET
- 16-90 12 YAWL AVENUE
- 16-92 10 YAWL AVENUE
- 16-93 8 YAWL AVENUE
- 16-95 78 FRIGATE STREET



Parcel ID: 15-20
LAPLANT, SANDRA L
26 SPANKER ST
JAMESTOWN RI 02835

Parcel ID: 15-22
ELLIOTT, JOHN WESLEY ET
KAPKO, KIMBERLY P.
20 SPANKER STREET
JAMESTOWN RI 02835-2431

Parcel ID: 16-102
JONES, PAUL
11 GONDOLA AVE.
JAMESTOWN, RI 02835

Parcel ID: 16-105
VAN CLEEF, ROBERT C ET
VAN CLEEF, PATRICIA S TRUSTEES
133 FRIGATE STREET
JAMESTOWN RI 02835

Parcel ID: 16-206
FANDETTI, PETER J
75 FRIGATE STREET
JAMESTOWN RI 02835

Parcel ID: 16-207
MEDEIROS, JOSEPH N.
65 FRIGATE STREET
JAMESTOWN RI 02835

Parcel ID: 16-208
PURNELL, DAVID
81 FRIGATE STREET
JAMESTOWN RI 02835

Parcel ID: 16-209
LANGLOIS, MICHAEL A
85 FRIGATE STREET
JAMESTOWN RI 02835

Parcel ID: 16-210
LANGLOIS, MICHAEL A
85 FRIGATE STREET
JAMESTOWN RI 02835

Parcel ID: 16-211
SCEMAMA, PASCAL H. ET UX
WOICKE, BETTINA
546 NEWTON STREET
CHESTNUT HILL MA 02467-3177

Parcel ID: 16-214
HARRIS, MARTHA J, TRUSTEE
209 BEACON AVENUE
JAMESTOWN RI 02835

Parcel ID: 16-63
TURILLO, SCOTT A. ET
TURILLO, CHRISTINE E, TRUSTEES
223 BEACON AVENUE
JAMESTOWN RI 02835

Parcel ID: 16-65
LEE, RICHARD H, TRUSTEE
209 BEACON AVENUE
JAMESTOWN RI 02835

Parcel ID: 16-71
RYNG-DUTTON, JANICE
1350 NORTH MAIN ROAD
JAMESTOWN RI 02835

Parcel ID: 16-73
THE SHORES LLC
C/O GUY SETTIPANE
270 GANO STREET
PROVIDENCE RI 02906

Parcel ID: 16-75
LOFGREN, ERIC S.
625 ANNAQUATUCKET ROAD
NORTH KINGSTOWN RI 02852-5603

Parcel ID: 16-81
TANTIMONACO, KARYN L
15 YAWL AVENUE
JAMESTOWN RI 02835

Parcel ID: 16-82
PECCHIA, CARL, TRUSTEE
PECCHIA MARIA C TRUST
11 YAWL AVENUE
JAMESTOWN RI 02835

Parcel ID: 16-84
CONANICUT ISLAND LAND TRUST
PO BOX 106
JAMESTOWN RI 02835

Parcel ID: 16-85
STOKES, GAIL & DAVID TE
86 FRIGATE STREET
JAMESTOWN RI 02835

Parcel ID: 16-90
O'CONNELL, DAVID E. & KELLY J.
12 YAWL AVENUE
JAMESTOWN RI 02835

Parcel ID: 16-92
DIORIO, JOSEPH A. JR., TRUSTEE
DELORES G.DIORIO TRUST
19 DERBY LANE
CRANSTON RI 02921-2927

Parcel ID: 16-93
DONATELLI, KATHRYN
8 YAWL AVENUE
JAMESTOWN RI 02835

Parcel ID: 16-95
CARELLA, DORIANNA ET AL
COLOGNESE, ANDREA TE
35 GONDOLA AVENUE
JAMESTOWN RI 02835

$$\begin{array}{r}
 \times 23 \\
 6.50 \\
 \hline
 156.46 \\
 200.00 \\
 \hline
 \$ 356.40
 \end{array}$$

Abbt.
App.



Office of the Town Planner MEMORANDUM

TO: Jamestown Zoning Board of Review
FROM: Lisa Bryer, AICP, Town Planner
RE: Motion for Zoning Section 82-314: High Groundwater Table and Impervious Overlay District, Sub-District A – Gail and David Stokes: AP 16, Lot 85; 86 Frigate Street, Jamestown, RI
DATE: June 18, 2020

At the June 17, 2020 a Planning Commission meeting, held remotely by Zoom where all Planning Commissioner were present, the Planning Commission voted unanimously to recommend to the Jamestown Zoning Board, approval of the application of Gail and David Stokes: AP 16, Lot 85; 86 Frigate Street, Jamestown, RI; being reviewed under Zoning Ordinance Section 314 - High Groundwater Table and Impervious Overlay District Sub-district A review in accordance with the plan entitled "Site Plan for AP 16 Lot 85, 86 Frigate Street in Jamestown RI" revision dated 5/14/2020 and revised 6/19/2020 after the Planning Commission meeting on June 17, 2020 where the applicant agreed to remove the shed and reduce the overall impervious cover. The plans are prepared by Principe Company, Inc. Engineering Division, PO Box 298, Tiverton, RI 02878, 401-816-5385

The recommendation for approval is based on the following findings of facts as amended:

Findings of Fact Section 314

1. The property is 7200 square feet (sf) in area;
2. The existing site is developed with a house, paved driveways, well, and a conventional OWTS;
3. Existing impervious cover is approximately **1908 sf or 26.5%**.
4. The OWTS was updated in 1998. The Town database indicates that the existing OWTS is current for maintenance;
5. Topography on the lot slopes from east to west on the site;
6. There are no freshwater wetlands on the property;
7. The soil evaluations conducted on the property were inconclusive in that they showed a large of amount of fill over the original soil horizons. Soil evaluation results from nearby lots were used to determine that the subject site falls under **Sub-district "A"** requirements of the High Groundwater Table and Impervious Overlay District. The maximum impervious cover allowed is **9% or 648 sf**;
8. The applicant is proposing to construct a 344 sf addition and a 22 sf covered porch. One area of paved driveway will be replaced with a permeable paver driveway. Approximately 875 sf total of existing paved surfaces will be removed on site in addition to 586 square feet of impervious cover will be reduced in the town right of way;

9. The applicant has volunteered to remove the existing shed to reduce impervious cover;
10. The total proposed impervious cover will be 1315 sf or 18.3% a reduction of 8.2% from the existing condition;
11. The existing well and OWTS will remain;
12. Two stone infiltration trenches are proposed to provide water quality treatment of new rooftop runoff.;
13. The applicant's representative Thomas J. Principe, III, PE, was certified as an expert witness by the Planning Commission and represented the applicant before the Planning Commission on 6-17-20;
14. Richard Lee, 209 Beacon Avenue spoke on behalf of the applicant;
15. The maximum allowable impervious coverage for this site is 9% or 648 sf. The proposed project exceeds the allowable area of impervious;
16. The required stormwater treatment volume for the new rooftops is 30.5 cubic feet (cf) and 75 cf are provided. The proposed BMP provides treatment for the 1" water quality volume for the new impervious surfaces on the site;
17. Jamestown Engineer Jean Lambert provided correspondence to Chris Costa, Building Official and Lisa Bryer, Town Planner dated June 10, 2020 regarding the Stokes application (attached). As noted above, the proposed project exceeds the allowable area of impervious cover; and
18. Engineer Thomas Principe testified that the size of the addition is the minimum required to accommodate accessible living in that house and that the primary purpose for the development proposal is handicap accessibility.

Recommended Conditions of Approval

1. A Special Use Permit for Section 314 is required from the Zoning Board of Review;
2. A variance is required from the Zoning Board of Review for exceeding the maximum allowable impervious surface coverage;
3. The area where the shed is removed shall be restored to pervious surface prior to the addition receiving a Certificate of Occupancy;
4. The proposed infiltration area must be physically delineated on the site prior to the commencement of construction to prevent compaction of the soil by heavy equipment;
5. An as-built plan shall be provided at the completion of construction to the Building Official depicting the size and location of the house, size and location of the rain gardens, and verifying the elevations and grading shown on the proposed site plan;
6. The OWTS must be inspected and maintained as required by the Town Onsite Wastewater Management Program. A maintenance contract must be recorded in the land evidence records and a copy of the recorded document shall be submitted to the Planning Department; and,

7. The Operation and Maintenance (O & M) Plan (reproduced in 8.5" x 11" for the stormwater mitigation (rain gardens) shall be recorded in the Office of the Town Clerk with the Zoning Approval and evidence of such shall be provided to the Zoning Enforcement Officer as well as the Planning Department.
8. An erosion and sediment control permit will be required from the building official prior to commencement of construction. Erosion and sediment controls shall be installed at the down gradient limit of disturbance as shown on the site plans. Erosion controls shall be maintained until final stabilization is achieved on the site.
9. Any additional future site work that increases the area of impervious coverage will require a review following the requirements of the High Groundwater Ordinance

Attachments: 1) Memo from Jean Lambert, PE June 10, 2020, revised June 18, 2020
2) A copy of the Application and Plan referenced above dated revised 6/19/20

C: Chris Costa, ZEO
David and Gail Stokes, Applicants
Richard Lee, applicant's representative, 86 Frigate Street
Thomas Principe, PE



Town of Jamestown, Rhode Island

Engineering/GIS Office

93 Narragansett Ave ♦ Jamestown, RI 02835 – 1509

Date: June 10, 2020; Revised June 18, 2020

To: Chris Costa, Building Official
Lisa Bryer, Town Planner

From: Jean Lambert, P.E.

RE: Zoning Section 82-314: High Groundwater Table and Impervious Overlay District, **Sub-District A**
Gail & David Stokes: AP 16, Lot 85; 86 Frigate Street, Jamestown, RI

I have reviewed the site plan entitled, "Site Plan for AP 16 Lot 85, 86 Frigate Street in Jamestown RI" revision dated 5/14/2020, prepared by Principe Company, Inc. for the above referenced property.

Existing Site/Soil Information:

The property is 7200 square feet (sf) in area. The existing site is developed with a house, paved driveways, well, and a conventional OWTS. The Town database indicates that the existing OWTS is current for maintenance. The OWTS was updated in 1998. Topography on the lot slopes from east to west on the site. There are no freshwater wetlands on the property. Existing impervious cover is approximately **1908 sf or 26.5%**.

The soil evaluations conducted on the property were inconclusive in that they showed a large amount of fill over the original soil horizons. Soil evaluation results from nearby lots were used to determine that the subject site falls under **Sub-district "A"** requirements of the High Groundwater Table and Impervious Overlay District. The maximum impervious cover allowed is **9% or a maximum of 648 sf**.

Proposed Site:

The applicant is proposing to construct a 344 sf addition and a 22 sf covered porch. Approximately 875 sf of existing paved surfaces will be removed. The total proposed impervious cover will be **1398 sf or 19.4%**. The existing well and OWTS will remain. One area of paved driveway will be replaced with a permeable paver driveway.

Two stone infiltration trenches are proposed to provide water quality treatment of new rooftop runoff. The required stormwater treatment volume for the new rooftops is 30.5 cubic feet (cf) and 75 cf are provided. The proposed BMP provides treatment for the 1" water quality volume for the new impervious surfaces on the site.

Zoning Section 82-314 Review

Impervious Coverage & Stormwater Management:

The proposed impervious cover is **19.4%**, a **reduction of 7.1%** from the existing condition. The maximum allowable impervious coverage for this site is 9% or 648 sf. The proposed project exceeds the allowable area impervious.

Recommendations/Conclusions:

- Erosion and sediment controls must be installed at the down gradient limits of site disturbance and maintained until stabilization of the site is attained.
- A zoning special use variance will be required for exceeding the maximum allowable impervious surface coverage.
- Any additional future site work that increases the area of impervious coverage will require a review following the requirements of the High Groundwater Ordinance.

Phone: 401-423-7193 Fax: 401-423-7226 Email: jlambert@jamestownri.net



Application Form
Jamestown Zoning Section 314
High Ground Water Table and
Impervious Layer Overlay District

SECTION I: GENERAL INFORMATION

PROPERTY OWNER: Call: David Stone's TELEPHONE: 401-560-0216
 MAILING ADDRESS: 9/ PROXY: RICHARD H. BEE #209 BERESN AVE. JT 02835

SITE LOCATION: #86 FRISCHTE. ST JT (STREET)
 PLAT: #16 LOT: #85 LOT AREA: 60' X 120'

PROJECT DESCRIPTION: CONSTRUCT 320 SQFT ADDITION - REDUCE IMPERVIOUS LAYER OVERLAY BY 7% BY TEARING UP CURRENT DRIVEWAY FOOTPRINT & REPLACING WITH SOIL. PURPOSE: TO RENDER DWELLING INTERIOR MORE HANDICAP-ACCESSIBLE FOR OWNER WITH CEREBRAL PARSY

SECTION II: SOIL INFORMATION

CLASS IV SOIL EVALUATOR:
 NAME: Thomas J Principe, PE RIDEM LICENSE #: D-4075 TELEPHONE: 401-816-5385
 NUMBER OF SOIL EVALUATIONS: 1 (ATTACH ALL SOIL EVALUATIONS)
 DEPTH TO SEASONAL HIGH GROUNDWATER TABLE (IN INCHES): None observed - 84" HTM
 DEPTH TO CATEGORY 9 SOILS (IN INCHES): -

OFFICE ONLY: SUB-DISTRICT CLASSIFICATION: A or B

SECTION III: OWTS INFORMATION

TYPE OF OWTS: Existing RIDEM PERMIT #: 9815-1893
 DISTANCE BETWEEN THE WELL AND LEACHFIELD: -
 OWTS AND WELL LOCATED ON THE SAME LOT AS THE STRUCTURE IT SERVES? Y OR N

SECTION IV: SITE INFORMATION

TYPE OF STORMWATER CONTROL SYSTEM: Stone trench along drip line
 TOTAL BUILDABLE AREA (TOTAL LOT AREA - WETLAND AREA): 7200
 PROPOSED IMPERVIOUS AREA: 1,398.4 sf (No wetlands on property)
 % IMPERVIOUS COVERAGE ALLOWED: 10
 % IMPERVIOUS COVERAGE PROPOSED: 19.4% 17% reduction in coverage
 (AREA IMPERVIOUS / TOTAL BUILDABLE AREA)

SECTION V: CONTACT INFORMATION

OWTS DESIGNER: Existing System
NAME: _____ RIDEM LICENSE #: _____

ADDRESS: _____

SIGNATURE: _____ DATE: _____

TELEPHONE: _____ EMAIL: _____

STORMWATER SYSTEM DESIGNER:
NAME: Thomas J. Principe, PE STATE LICENSE #: 9107

ADDRESS: 27 Sakonnet Ridge Drive
Tiverton RI 02878

SIGNATURE: _____ DATE: 4/8/20

TELEPHONE: 401-816-5385 EMAIL: principeengineering@gmail.com

APPLICANT CONTACT INFORMATION:

NAME: RICHARD H. LEE

ADDRESS: #209 BEACON AVE., JAMESTOWN 02835

SIGNATURE:  DATE: 4-6-20

TELEPHONE: LAND: 423-2706 EMAIL: dlee60@verizon.net
CELL: 617-512-2034

SUBMISSION REQUIREMENTS

Submit one copy of the following items for preliminary review. Applicant will be notified when additional copies are required for Planning Board review.

- Application Form
- Site Plan
- Soil Evaluations (include all results for site)
- Stormwater Analysis
- Project Narrative
- Proposed Building Floor Plans (if applicable)
- Approved RIDEM OWTS permit
- O&M Requirements for Stormwater Mitigation

Contact Jean Lambert at 423-7193 or jlambert@jamestownri.net with questions regarding HGWT applications.

VEGETATIVE COVER AND PLANTING

- THE NORMAL ACCEPTABLE SEASONABLE SEEDING DATES ARE APRIL 1ST THROUGH OCTOBER 15TH.
 - TOP SOIL FOR PERMANENT OR LONG TERM TEMPORARY SEEDING SHOULD HAVE A SANDY LOAM TEXTURE, RELATIVELY FREE OF STONES, MATERIALS, STONES, ROOTS, LIMBS OF SOIL, TREE LIMBS, TRASH OR CONSTRUCTION DEBRIS. TOP SOIL SHALL COMPARE WITH RHODE ISLAND SPECIFICATIONS W8.01.
 - THE DESIGN SEED MIX UTILIZED IN ALL DISTURBED AREAS TO BE SEEDED SHALL BE COMPRISED OF THE FOLLOWING:
- | TYPE | R BY WEIGHT | SEEDING DATE |
|---------------------|-------------|------------------------|
| CREeping RED FESCUE | 70 | |
| ASTORIA BENTGRASS | 5 | APRIL 1 - JUNE 15 |
| BROODFOOT TITCUL | 15 | AUGUST 15 - OCTOBER 15 |
| PERENNIAL RYE GRASS | 10 | |
- APPLICATION RATE - 100 LBS PER ACRE
- SEED MIX SHALL BE INOCULATED WITHIN 24 - HOURS BEFORE MOWING AND PLANTING, WITH APPROPRIATE INOCULATION FOR THE SPECIFIC VEGETATION. ALTERNATE SEED TYPES DUE TO SITE SPECIFIC CONDITIONS AND SOILS ARE ACCEPTABLE WITH THE ENGINEER'S APPROVAL.
- SOIL SEEDING AREAS, THE CONTRACTOR WILL LIMB AND FERTILIZE AS REQUIRED TO COMPLIMENT OR UPGRADE SOIL CONDITIONS.
 - THE CONTRACTOR MUST REPAIR AND/OR RESEED ANY PERMANENT VEGETATIVE COVER AREAS THAT DO NOT DEVELOP OR WHICH ERODE WITHIN A ONE (1) YEAR PERIOD.

EROSION CONTROL, SOIL STABILIZATION AND SEDIMENT CONTROL PLAN

- PROVIDE TO THE COMPLETION OF ANY CLEANING, EROSION, DENOUDATION OR EARTHWORK ACTIVITY, TEMPORARY EROSION AND SEDIMENT CONTROL MEASURES AS INDICATED ON THE PLANS ARE TO BE INSTALLED BY THE CONTRACTOR.
- CONSTRUCTION ACCESS STABILIZATION ENTRANCE PADS ARE TO BE INSTALLED PRIOR TO THE COMMENCEMENT OF SITE GRUBBING OR EARTHWORK ACTIVITY.
- EXISTING CATCH BASINS ARE TO BE PROTECTED WITH HAY BALES AND/OR SILT BAGS PRIOR TO THE START OF SITE GRUBBING, EARTHWORK OR UNDERGROUND UTILITY AND DRAINAGE INFRASTRUCTURE INSTALLATION TO SERVE THE DEVELOPMENT SITE.
- THE PROJECT CONSTRUCTION SEQUENCE, TO THE EXTENT PRACTICAL SHOULD REQUIRE THE INSTALLATION OF EROSION CONTROL MEASURES PRIOR TO THE COMMENCEMENT OF EARTHWORK ACTIVITY.
- TEMPORARY SITE SLOPE TREATMENTS FOR SOIL STABILIZATION SHALL CONSIST OF HAY STRAW, FIBER MATTING, RIP RAP OR PROTECTIVE COVERS SUCH AS MAT OR FIBER LINING (BURLAP, JUTE, FIBERGLASS, AND EGOLEOR OR EQUAL PRODUCTS). THESE AND OTHER ACCEPTABLE MEASURES SHALL BE INCORPORATED INTO THE SITE WORK AS WARRANTED OR AS ORDERED BY THE ENGINEER.
- CONSTRUCTION SITES ARE PROVIDED, THE CONTRACTOR IS RESPONSIBLE FOR THE INSTALLATION AND OR MAINTENANCE OF EROSION CONTROL MEASURES AS NEEDED TO MAINTAIN AND CONTROL EROSION THROUGHOUT THE CONSTRUCTION PERIOD.
- THE CONTRACTOR SHALL BE RESPONSIBLE FOR PERIODIC INSPECTION, MAINTENANCE, REPAIR, AND ACCEPTABLE PERMANENT EROSION CONTROL. SOIL STABILIZATION AND SEDIMENT CONTROL DEVICES UNTIL AN ACCEPTABLE PERMANENT EROSION CONTROL MEASURE IS INSTALLED SHALL BE MAINTAINED THROUGHOUT THE DETAILED LOG OF ALL EROSION CONTROL INSPECTIONS COMPLAINTS RELATED TO EROSION OR SEDIMENT, AND CORRECTIVE REMEDIAL MEASURES TAKEN THROUGHOUT THE COURSE OF THE PROJECT CONSTRUCTION.
- SOIL EROSION AND SEDIMENT CONTROL IS NOT LIMITED TO DAMAGES CAUSED BY WATER BUT ALSO INCLUDES DAMAGES CAUSED BY WINDS, MEASURES SUCH AS TEMPORARY GROUND COVERS, WATER AND DUST CONTROL MEASURES ARE TO BE UNDERTAKEN AS NEEDED TO MINIMIZE WIND RELATED SOIL AND DUST CONTROL.
- STOCK PILES OF EARTH MATERIALS SHALL NOT BE LOCATED NEAR WATERWAYS OR WETLANDS. STOCK PILES SHALL HAVE SOLE SLOPES NO GREATER THAN THIRTY PERCENT (30%). STOCK PILES SHALL BE FENCED BY HAY BALES OR SILT FENCES. THE STOCK PILES SHALL ALSO BE SEED OR STABILIZED IN SOME MANNER TO PREVENT SOIL EROSION.
- TO THE EXTENT POSSIBLE, ALL DISTURBED AREAS MUST BE SEED OR STABILIZED WITHIN THE (15) DAYS OF FINAL GRADING.
- EXPOSED SEED OR LIMB SLOPES SHOULD BE THE ONLY WITH "COMBING" OR "TRACKING" TO REDUCE EROSION AND SEDIMENT AND TO TRACK DOWN DEBRIS ON EACH APPLICATION.
- IF CONCRETE IS TO BE USED ON SITE, THE CONTRACTOR SHALL ESTABLISH AND MAINTAIN SPECIFIC WASHOUT AREAS FOR THE CONCRETE TRUCKS WITH APPROPRIATE PROTECTION CONTROLS.
- THE CONTRACTOR IS RESPONSIBLE FOR PROVIDING HAY MATS AND STORAGE LOCATIONS ON-SITE FOR ALL CONSTRUCTION DEBRIS AND TRASH SO THAT THIS MATERIAL DOES NOT BECOME A NEIGHBORHOOD NUISANCE.
- EXISTING TREES AND VEGETATION WILL BE RETAINED WHENEVER FEASIBLE.
- SITE SOIL EROSION AND SOIL STABILIZATION AND SEDIMENT CONTROL MEASURES SHALL CONFORM TO ALL REQUIREMENTS OF THE APPLICABLE LOCAL, STATE AND FEDERAL REGULATIONS.

ROOF DRAINAGE CALCULATIONS:

PROPOSED ROOF AREA = 366 S.F.
 DRAINAGE AREA REQUIRED (12" RAIN):
 366 S.F. / 12" = 30.50 CF
 TRENCH DEPTH = 24"
 TRENCH WIDTH = 18"
 CONSTRUCTION AND REUSE, REFER TO THE SECOND DATE
 FOR STABILIZING TEMPORARY EXPOSED SLOPES AS WELL AS PERMANENT BEING.
 AREA PROVIDED = 24.00 S.F. > 30.50 CU FT REQUIRED
 OK.

APPROXIMATE EARTHWORK QUANTITIES:

THERE WILL BE MINIMAL EARTHWORK NEEDED FOR THIS PROJECT
 FINAL GRADING TO MATCH ALL EXISTING GRASSES FOR THE SITE
 THE EXISTING LOAM ON SITE WILL BE STOCKPILED PRIOR TO
 CONSTRUCTION AND REUSE, REFER TO THE SECOND DATE
 FOR STABILIZING TEMPORARY EXPOSED SLOPES AS WELL AS PERMANENT BEING.
 *CONTRACTOR TO COMPLY WITH THE SUBMITTED "SWEEP" DOCUMENT



STONE TRENCH DETAIL
 NOT TO SCALE

PAVER NOTES:

- CONTRACTOR TO INSTALL MANHOLE, 48" DI. PERMANIBLE PAPER OR APPROVED EQUAL PER MANUFACTURER'S SPECIFICATIONS.
- CONTRACTOR TO DISBURSE PERMANIBLE PAPER COMPLES WITH AMERICAN DISBURSES ACT SPECIFICATIONS.

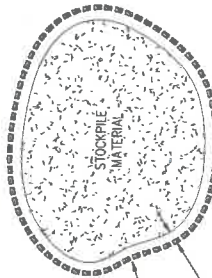
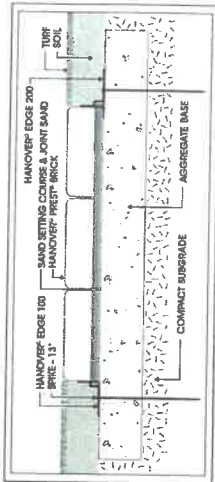

STOCKPILE DETAIL
 NOT TO SCALE

PRINCIPLE COMPANY, INC.
 ENGINEERING DIVISION
 100 BOX NEW
 02870
 01541-02870
 PRINCIPLES@PRINCIPLES.COM

SITE PLAN
 for
 40 18 LOT B5
 86 FRIGATA STREET
 JAMESTOWN, RHODE ISLAND

SCALE: AS NOTED
 SHEET NO: 2 OF 2
 DRAWN BY: L.P.
 DESIGN BY: L.P.
 CHECKED BY: L.P.
 DATE: 3/19/20
 PROJECT NO: ENSC-2020-3

NO.	DATE	BY	CHKD	DESCRIPTION
1	3/19/20	L.P.	L.P.	ISSUED FOR PERMIT
2	3/19/20	L.P.	L.P.	ISSUED FOR PERMIT
3	3/19/20	L.P.	L.P.	ISSUED FOR PERMIT

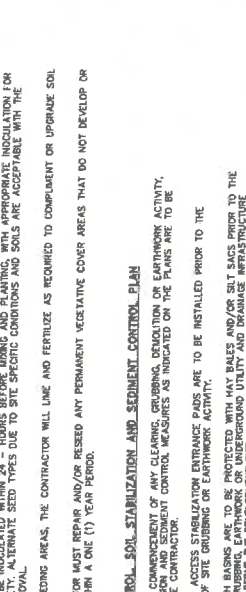

SILT FENCE DETAIL
 NOT TO SCALE

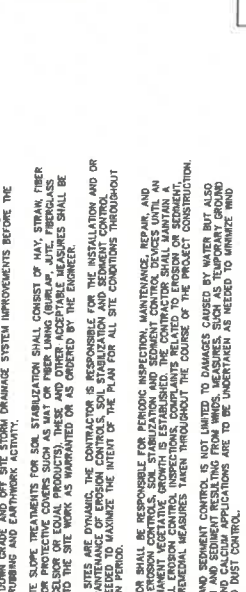

ROCK ISLAND DEPARTMENT OF TRANSPORTATION
 NOT TO SCALE



Application Form
Jamestown Zoning Section 314
High Ground Water Table and
Impervious Layer Overlay District

SECTION I: GENERAL INFORMATION

PROPERTY OWNER: GAIL & DAVID STOKES TELEPHONE: 401-560-0216
 MAILING ADDRESS: c/o PROXY: RICHARD H. LEE #209 BEACON AVE. JT 02835

SITE LOCATION: #86 FRIGATE ST JT (STREET)

PLAT: #16 LOT: #84 LOT AREA: 60' X 120'

PROJECT DESCRIPTION: CONSTRUCT 320 SQ FT ADDITION - REDUCE IMPERVIOUS LAYER OVERLAY BY 7% BY TEARING UP CURRENT DRIVEWAY FOOTPRINT & REPLACING WITH SOIL. PURPOSE: TO RENDER DWELLING INTERIOR MORE HANDICAP-ACCESSIBLE FOR OWNER WITH CEREBRAL PALSY

SECTION II: SOIL INFORMATION

CLASS IV SOIL EVALUATOR:

NAME: Thomas J Principe, PE RIDEM LICENSE #: D-4075 TELEPHONE: 401-816-5385

NUMBER OF SOIL EVALUATIONS: 1 (ATTACH ALL SOIL EVALUATIONS)

DEPTH TO SEASONAL HIGH GROUNDWATER TABLE (IN INCHES): None observed - 84" HTM

DEPTH TO CATEGORY 9 SOILS (IN INCHES): -

OFFICE ONLY: SUB-DISTRICT CLASSIFICATION: A or B

SECTION III: OWTS INFORMATION

TYPE OF OWTS: Existing RIDEM PERMIT #: 9815-1893

DISTANCE BETWEEN THE WELL AND LEACHFIELD: -

OWTS AND WELL LOCATED ON THE SAME LOT AS THE STRUCTURE IT SERVES? Y OR N

SECTION IV: SITE INFORMATION

TYPE OF STORMWATER CONTROL SYSTEM: Stone trench along drip line

TOTAL BUILDABLE AREA (TOTAL LOT AREA - WETLAND AREA): 7200 sf
(No wetlands on property)

PROPOSED IMPERVIOUS AREA: 1,398.4 sf

% IMPERVIOUS COVERAGE ALLOWED: 10

% IMPERVIOUS COVERAGE PROPOSED: 19.4% (7% reduction in coverage)
 (AREA IMPERVIOUS / TOTAL BUILDABLE AREA)

SECTION V: CONTACT INFORMATION

OWTS DESIGNER: Existing System
NAME: _____ RIDEM LICENSE #: _____

ADDRESS: _____

SIGNATURE: _____ DATE: _____

TELEPHONE: _____ EMAIL: _____

STORMWATER SYSTEM DESIGNER:
NAME: Thomas J. Principe, PE STATE LICENSE #: 9107

ADDRESS: 27 Sakonnet Bridge Drive
Tiverton RI 02878

SIGNATURE: _____ DATE: 4/2/20

TELEPHONE: 401-816-5385 EMAIL: principeengineering@gmail.com

APPLICANT CONTACT INFORMATION:

NAME: RICHARD H. LEE

ADDRESS: #209 BEACON AVE., JAMESTOWN 02835

SIGNATURE:  DATE: 4-6-20

TELEPHONE: LAND: 423-2706 EMAIL: dlee60@verizon.net
CELL: 617-512-2034

SUBMISSION REQUIREMENTS

Submit one copy of the following items for preliminary review. Applicant will be notified when additional copies are required for Planning Board review.

- Application Form
- Site Plan
- Soil Evaluations (include all results for site)
- Stormwater Analysis
- Project Narrative
- Proposed Building Floor Plans (if applicable)
- Approved RIDEM OWTS permit
- O&M Requirements for Stormwater Mitigation

Contact Jean Lambert at 423-7193 or jlambert@jamestownri.net with questions regarding HGWT applications.

To: Ms. Jean Lambert
From: Gail and David Stokes
#86 Frigate St.
Date: April 6th, 2020
Re: Application Form
Jamestown Zoning Section 314
High Ground Water table, etc.

Please be aware that Mr. Richard H. Lee at #209 Beacon Ave. is overseeing for us the application process regarding a building permit for #86 Frigate St.

As noted on the application, he should be the contact person for any communications with the Town. He, in turn, will keep us informed of developments.



David L. Stokes, Jr

4/6/20
Date

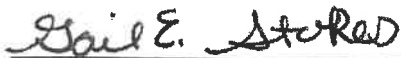

Gail E. Stokes

4/6/20
Date

TOWN OF JAMESTOWN
ZONING BOARD OF REVIEW

Application for Exception or Variance under the Zoning Ordinance

Zoning Board of Review;

Jamestown, R.I.

Date: June 22, 2020

Gentlemen:

The undersigned hereby applies to the Zoning Board of Review for an exception or a variation in the application of the provisions or regulations of the zoning ordinance affecting the following described premises in the manner and on the grounds hereinafter set forth.

Applicant: Andrew and Colleen MacIntyre Address: c/o Christian Infantolino, Esq.,
77 Narragansett Avenue
Jamestown, RI 02835

Owner: Same

Lessee: None

1. Location of premises: 9 Maple Avenue, Jamestown RI
2. Assessor's Plat 9 Lot 14
3. Dimensions of lot: frontage _____ ft. depth: _____ ft. Area: 30492 sq. ft.
4. Zoning Districts in which premises are located: Use: R20 Area: 20,000 sq. ft. Height: 35 ft.
5. How long have you owned the premises? 9/14/1999
6. Is there a building on the premises at present? Yes
7. Size of existing building: +/- 2358 sq. ft.
Size of proposed building or alteration: +/- 200 sq. feet (8ft x 25 ft deck)
8. Distance of proposed building or alteration from lot lines:
Required: front: 30' rear: 30' side: 10'
Existing: front: 19.8'+/-
Proposed: front: 17+/-; no change on any other existing setback
9. Present use of premises: Single family residence
10. Proposed use of premises: Single family residence

Location of septic tank & well on lot: No Change

11. Give extent of proposed alterations: Applicant proposes to replace the existing six (6) foot deck with a front porch about 8ft deep x 25 ft.

12. Number of families for which building is to be arranged: 1

13. Have you submitted plans for above to Inspector of Buildings? Yes

Has the Inspector of Buildings refused a permit? Yes

14. Provision or regulation of Zoning Ordinance or State Enabling Act under which application for exception or variance is made:

This application seeks relief from Section 82-302, District dimensional regulations and Table 3-2, R20 Zoning District regulations, to replace the existing six (6) foot deck with a front porch 8 feet deep by approximately 25 feet wide, where the existing deck is approximately 19.8 feet from the front property line and the proposed porch is 17 feet from the front property line where 30 feet is required. The Applicant also seeks relief from Article 7 Section 82-705 as the existing structure is currently located approximately 19.8 feet from the front property line.

15. State the grounds for exception or variation in this case:

This property possesses unique characteristics that require the relief requested.

This hardship is present due to the unique characteristics of the subject lot.

The granting of the requested variance will not alter the general characteristic of the surrounding area.

The relief requested is the least relief necessary.

The hardship amounts to more than a mere inconvenience without the requested relief.

The requested relief will allow the applicant to construct a front porch that aesthetically fits with the neighborhood and surrounding properties.

Respectfully Submitted,

Signature: /s/ christian s. infantolino
77 Narragansett Avenue
Jamestown, RI 02835

Phone: 401-423-0400

NOTE: A LOCATION PLAN AND SKETCH AND DRAWINGS NECESSARY TO GIVE FULL INFORMATION MUST BE FILED WITH THE APPLICATION

Notice of Hearing

Application of Andrew and Colleen MacIntyre whose property is located at 9 Maple Avenue, Jamestown RI 02835, and further identified as Tax Assessor's Plat 9, Lot 14 for dimensional relief granted under Article 6, Special Use Permits and Variances, pursuant to Section 82-302, Table 3-2 for the Village Special District Zones R8, R20, CL and CD4, to construct a proposed porch with a front setback of 17 feet where 30 feet is required. The applicant is also seeking relief from Article 7 Section 82-705, Alteration of a nonconforming structure where the subject property currently has a deck that is approximately 19 feet from the front property line were 30 feet is required. Said property is located in a R20 zone and contains approximately 30492 square feet.



LOCUS
Not to Scale

Min. Side Yard: 10'
Min. Rear Yard: 30'
Max. Bldg. Height: 35'
* Please refer to Zoning for additional information

Underground utilities shown have been located from field observations and existing drawings. The Surveyor makes no warranty as to the location of the underground utilities shown, either in service or abandoned. The Surveyor does not warrant that the underground utilities are located as accurately as possible, although they are located as accurately as possible available. The Surveyor has not physically located underground utilities. (Please contact DIGSAFE prior to any excavation. 1-888-344-7233.)

Properties located within Zone X (Areas determined to be in a 1% annual chance floodplain) & Zone AE (E1.26) are subject to a Flood Insurance rate map # 44005C0157J for the Town of Jamestown, Rhode Island, Newport County, effective as of September 04, 2013.

Map of the Town of Jamestown Downtown Special District.

S:

Original Plat of the Laid out by J.P. Cotton - C.E. Newport - R.I. 1871. Scale: 1"=100' on file in the Town of Jamestown Land File HPF 268B.

Plat, Jamestown, R.I. Surveyed and Platted by J.P. Cotton, R.I. July 31, 1913 Scale: 1"=100' on file in the Town of Jamestown Land Records Hanging File HPF 268B.

Plat of Land, Jamestown, R.I. Scale: 1"=40' Surveyed by J.P. Cotton, Newport, R.I. May 22, 1913 on file in the Town of Jamestown Land Record L.E.R. 18, Page 296.

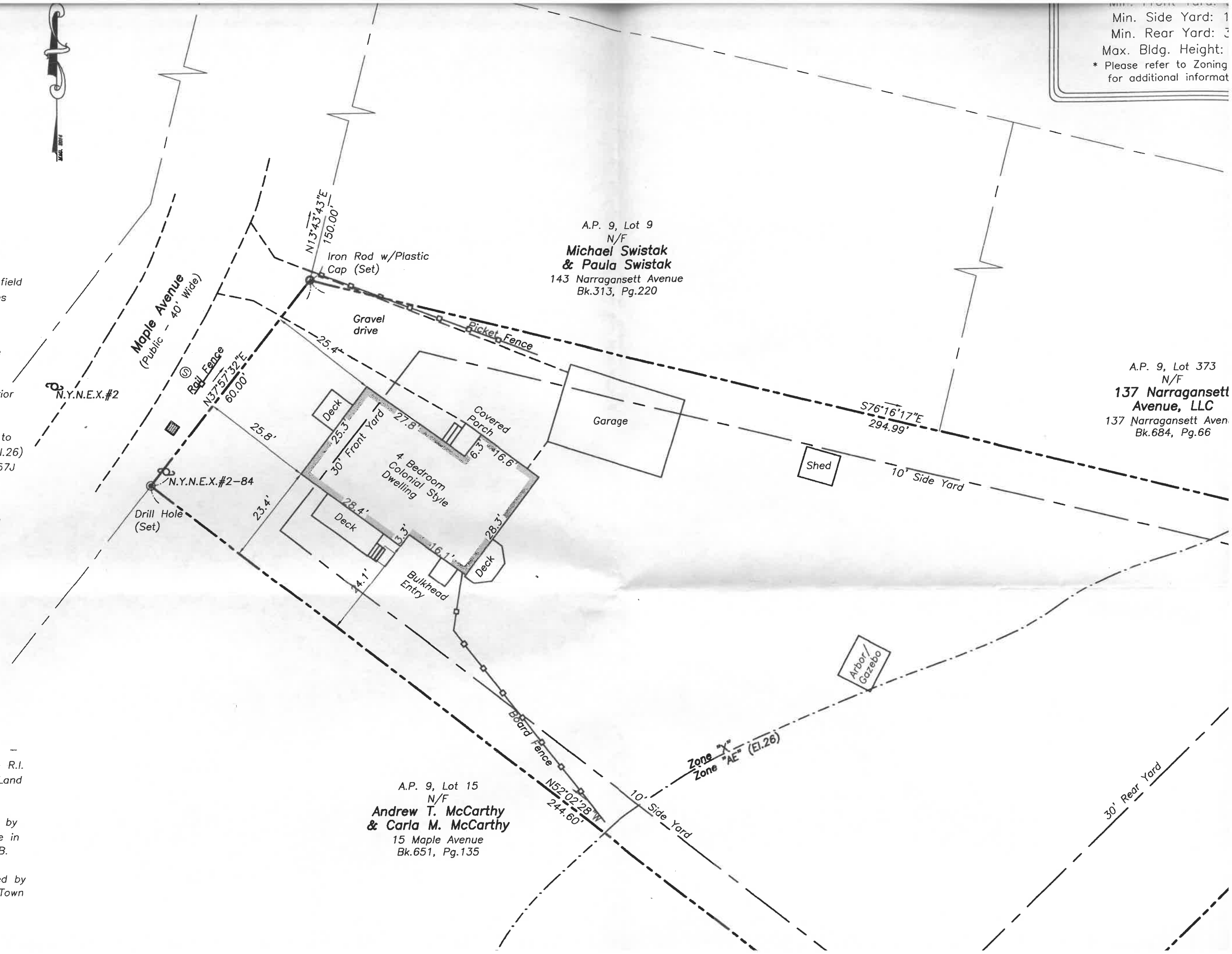

A.P. 9, Lot 9
N/F
**Michael Swistak
& Paula Swistak**
143 Narragansett Avenue
Bk.313, Pg.220

A.P. 9, Lot 373
N/F
**137 Narragansett
Avenue, LLC**
137 Narragansett Avenue
Bk.684, Pg.66

A.P. 9, Lot 15
N/F
**Andrew T. McCarthy
& Carla M. McCarthy**
15 Maple Avenue
Bk.651, Pg.135

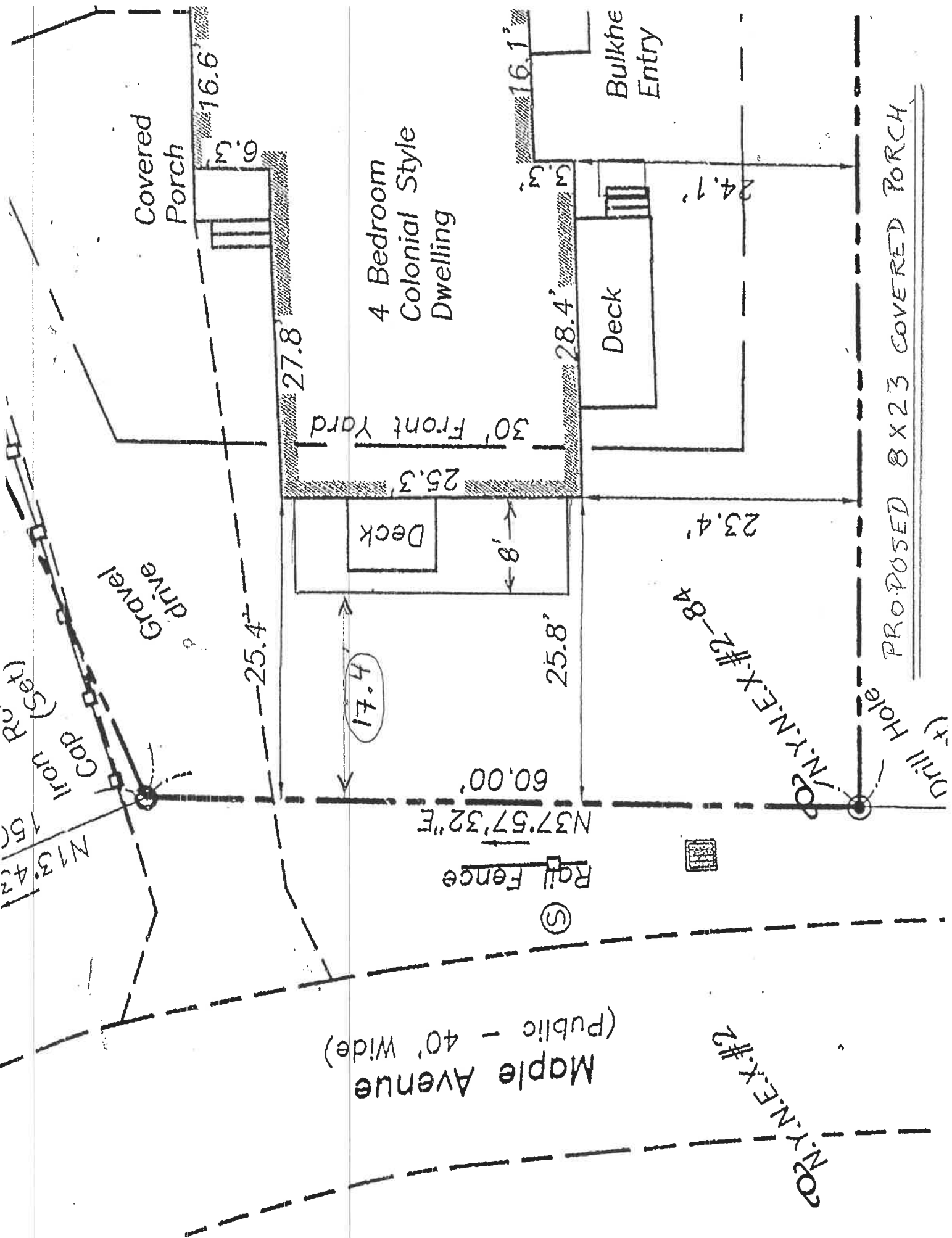

4 Bedroom
Colonial Style
Dwelling

Covered
Porch

Bulkhead
Entry

Deck

Deck

PROPOSED 8 X 23 COVERED PORCH

30' Front Yard

Gravel
drive

Iron Cap
Cap (Set)

Rail Fence

Drill Hole

Maple Avenue
(Public - 40' Wide)

N.Y.N.E.X.#2

N.Y.N.E.X.#2-84

N13°42'

N37°57'32"E

15'

60.00'

25.4'

17.4'

25.8'

23.4'

8'

25.3'

27.8'

28.4'

24.1'

16.1'

16.6'

6.3'

(5)

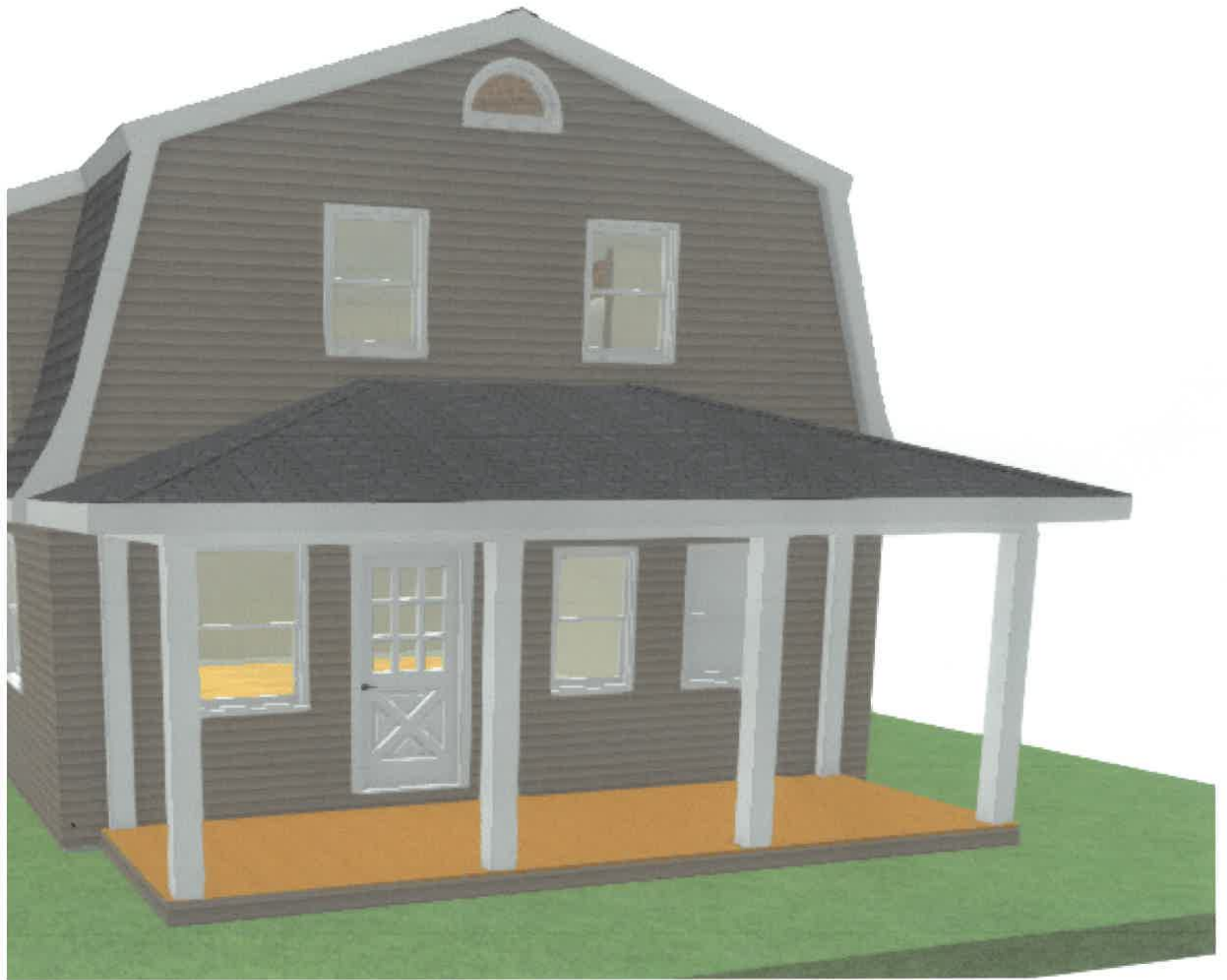

posed covered porch

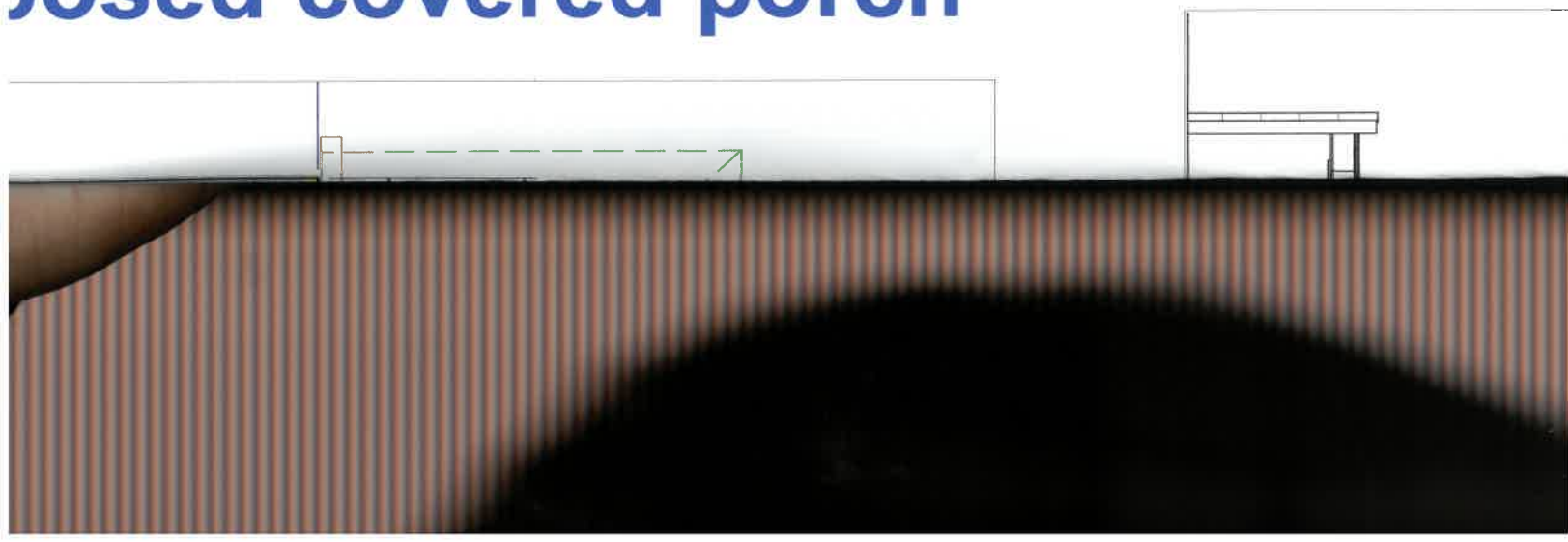

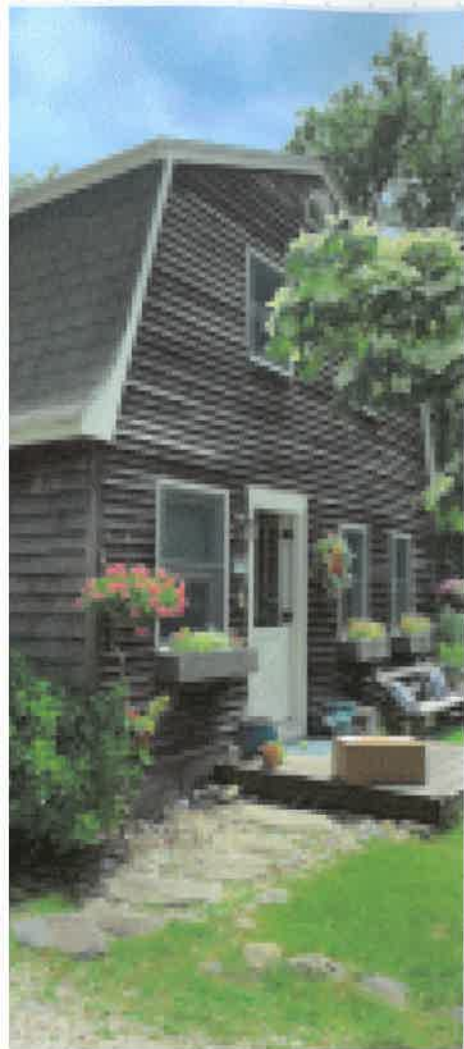

existing gable end condition





existing gable end condition



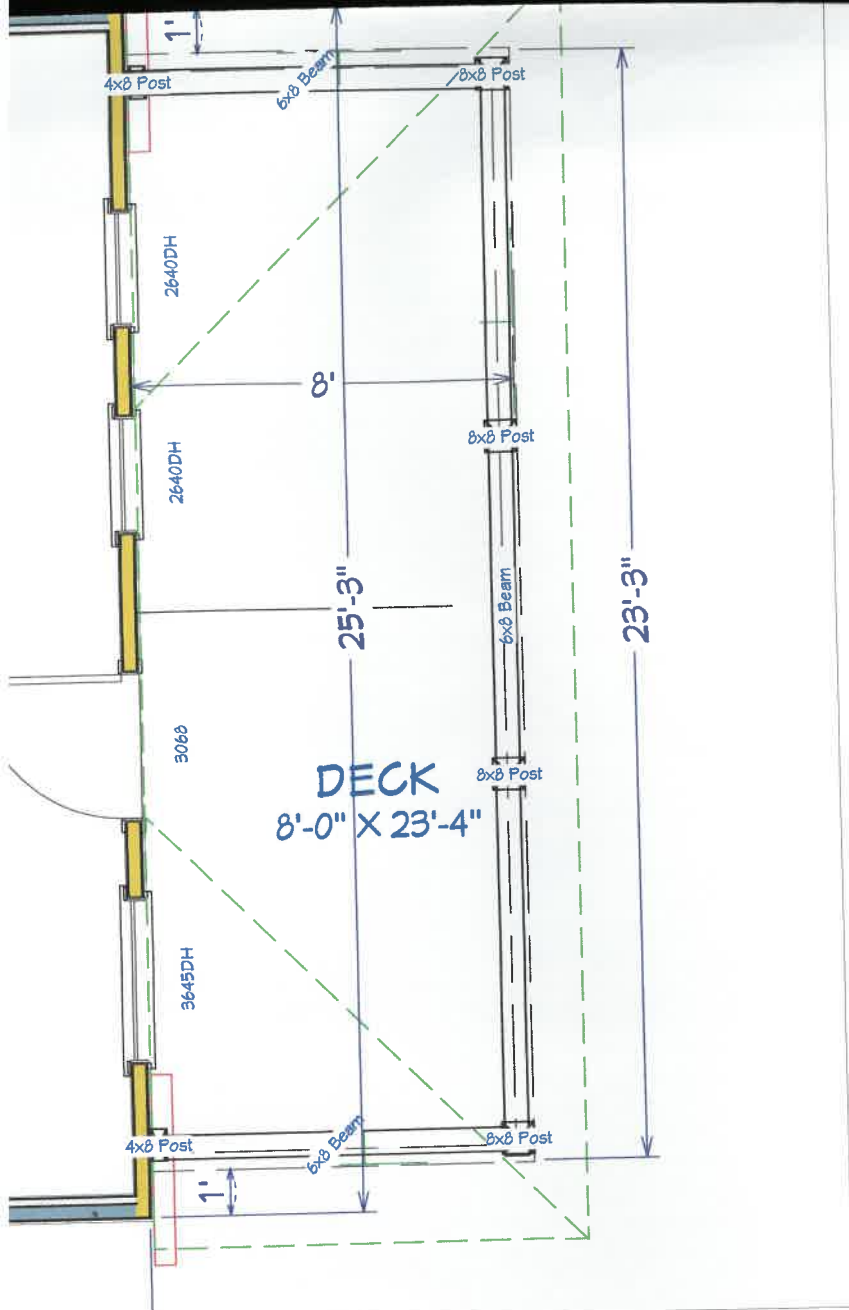

Plan

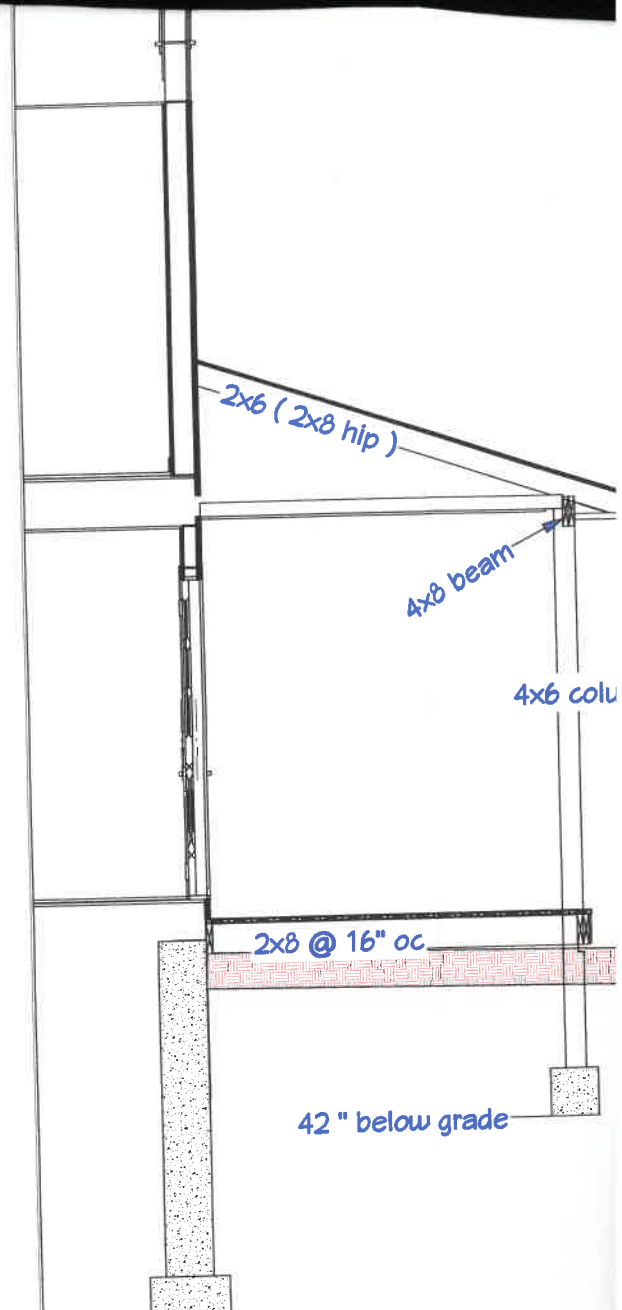

construction section

scale 1/4" = 1 ft.

DATE: 6 / 19 / 20

SCALE:

Parcel ID: 9-10
WEST FERRY PROPERTIES LLC
129 NARRAGANSETT AVE
JAMESTOWN RI 02835

Parcel ID: 9-11
WEST FERRY PROPERTIES LLC
129 NARRAGANSETT AVENUE
JAMESTOWN RI 02835

Parcel ID: 9-12
BROWN, LINDA F
121 NARRAGANSETT AVE
JAMESTOWN, RI 02835

Parcel ID: 9-13-4
LUSH, ANTHONY ET
LUSH, NANCY
PO BOX 651
JAMESTOWN, RI 02835

Parcel ID: 9-13-1
NEWPORT HEALTH PROPERTY
MANAGEMENT, INC.
765 ALLENS AVE, STE. 100
PROVIDENCE RI 02905

Parcel ID: 9-13-2N
NEWPORT HEALTH PROPERTY
MANAGEMENT, INC.
765 ALLENS AVE, STE. 100
PROVIDENCE RI 02905

Parcel ID: 9-13-3
EVAN REALTY ASSOC. LLC
P.O. BOX 408
JAMESTOWN, RI 02835

Parcel ID: 9-13

Parcel ID: 9-13-2S
NEWPORT HEALTH PROPERTY
MANAGEMENT, INC.
765 ALLENS AVE, STE. 100
PROVIDENCE RI 02905

Parcel ID: 9-14
MACINTYRE, ANDREW K ET
MACINTYRE, COLLEEN D
9 MAPLE AVE
JAMESTOWN RI 02835

Parcel ID: 9-15
TAMBOE, KENNETH G TRUSTEE
TAMBOE, EMILIE M TRUSTEE
15 MAPLE AVENUE
JAMESTOWN RI 02835

Parcel ID: 9-16
SIMMONS, JAMES D ET
AUBOIS, SUZANNE M
17 MAPLE AVE
JAMESTOWN RI 02835

Parcel ID: 9-365
LAMBERT, ROBERT H JR ET
LAMBERT, JEAN Z
20 MAPLE AVE
JAMESTOWN, RI 02835

Parcel ID: 9-373
137 NARRAGANSETT AVENUE, LLC
C/O DIAMOND STAR PROPERTY
MANAGEMENT
P.O. BOX 8397
CRANSTON RI 02920

Parcel ID: 9-409
SCHLACHTER, ANDREW J ET
FEELEY, LACEY M.
10 MAPLE AVENUE
JAMESTOWN RI 02835

Parcel ID: 9-6
COLLIE, JEREMY & ELIZABETH M.
151 NARRAGANSETT AVENUE
JAMESTOWN RI 02835

Parcel ID: 9-621
WASHBURN, ARTHUR H JR & JANICE E
PO BOX 172
JAMESTOWN, RI 02835-0172

Parcel ID: 9-777
BOURASSA, JAMIE J ET UX
BOURASSA, MELISSA A TE
157 NARRAGANSETT AVENUE
JAMESTOWN RI 02835

Parcel ID: 9-813
JAMESTOWN FOUR CORNERS INC
125 NARRAGANSETT AVENUE
JAMESTOWN, RI 02835

Parcel ID: 9-814
ROMA ENTERPRISES, LLC
30A SOUTHWEST AVENUE
JAMESTOWN RI 02835

Parcel ID: 9-9
SWISTAK, MICHAEL ET
SWISTAK, PAULA
143 NARRAGANSETT AVENUE
JAMESTOWN RI 02835

16
x 6.80

108.80
+ 200.00

\$ 308.80

**Michael & Paula Swistak
143 Narragansett Avenue
Jamestown RI 02835**

6 July 2020

Town of Jamestown
93 Narragansett Avenue
Jamestown RI 02835

Attn: Chris Costa, Zoning Official

Re: Andrew & Colleen MacIntyre – 8 Maple Avenue
Setback Variance Application

Dear Chris,



Please accept this letter in support of the Setback Variance Application submitted to the Zoning Board for consideration, by Andrew and Colleen MacIntyre of 8 Maple Avenue, Jamestown.

We are direct abutters to the MacIntyre property, and have no reservations with regard to their request for relief from the Zoning Regulations.

In fact, we endorse their application to enhance the exterior of their home with the addition of a front porch.

Please add this letter to the official record when the application is presented to the Zoning Board.

Sincerely,

Michael & Paula Swistak

CC: Richard Boren Esq., Zoning Board Chairperson
Patricia Westall, Zoning Clerk
Andrew & Colleen MacIntyre

11 copies

TOWN OF JAMESTOWN
ZONING BOARD OF REVIEW

Application for Exception or Variation under the Zoning Ordinance

Zoning Board of Review:

Jamestown, Rhode Island

Date 6/19/20

Gentlemen/Ladies:

The undersigned hereby applies to the Zoning Board of Review for an exception or a variation in the application of the provisions or regulations of the zoning ordinance affecting the following described premises in the manner and on the ground hereinafter set forth.

Applicant: Andrew Bilodeau Esq., 1350 Division Rd #102, West Warwick, RI 02893

Owner - same as applicant

Lessee - N/A

Location of premises: No. - N/A Street - Beach Ave

1. Assessor's Plat 5, Lot 164
2. Dimensions of the lot: Frontage - 120 ft, Depth - 180 ft, Area - 21,600 sq ft
3. Zoning District in which premises is located: R-40
4. How long have you owned above premises? One Year +
5. Is there a building on the premises at present - No
6. Size of existing building - N/A Size of proposed building or alteration - 51' x 30' = 1530 sf
7. Distance of proposed building or alteration from lot lines:
Front - 30' Rear - 90' Left Side - 10', Right Side - 59'
8. Present use of premises: - Vacant land
9. Proposed use of premises: single family
10. Location of septic tank and well on lot - See site plan

11. Give extent of proposed alterations: Construction of single family house

12. Number of families for which building is to be arranged: one

14. Have you submitted plans for above to Inspector of Buildings? Yes

Inspector of Building refused a permit? yes

15. Provision or regulation of Zoning Ordinance or State Enabling Act under which application for exception or variance is made:

Application of Andrew Bilodeau whose property is located at Beach Ave x Riptide St, and further identified as Tax Assessor's Plat 5, Lot 164 for a Variance/Special Use Permit from Article 3, Section 82-314 High Ground Water Ordinance Sub-District A and Section 82-302-2 Table 3-2 "Setbacks",

Article 6, Section 82-601 Section "Special Use Permits" and Sections 82-605 & 82-606 to construct a single family dwelling with a front yard setback of 30' where 40' is required in a High Groundwater Sub-district A. Said property is located in an R-40 zone and contains 21,600 sf

16. State grounds for exceptions or variation in this case:

Lot is 21,600 sf however, it contains 6038sf of forested wetlands and 6143sf of wetlands buffer leaving 9419sf buildable area. The required side yard setbacks are 10' and the front is 40'. The rear of the proposed house averages 17' from the wetlands buffer. With the inclusion of the OWTS and the rain garden for stormwater control the buildable area for the lot is reduced considerably. We are proposing to place the building 30' from the front yard lot line which requires 10' of dimensional relief. The height of the house is allowed to be 35' by the zoning ordinance (No design yet). The location of the lot is such that a two or three story house would access a west passage water view from the upper stories. Water view, view corridor obstruction always cause consternation with upland abutters. Fortunately in this case the upland area (to the west) is a very large area of forested

wetlands which are unbuildable. Thus we do not anticipate view corridor conflicts with the development.

The OWTS #9015-0061 was previously approved with an expiration date of 10-06-2019 however the previous owner (Catanzaro) called in a start of construction on 10-02-2019 which extended the expiration date to 10-02-2020.

The RIDEM wetlands permit, #11-0199 expires July 1, 2020.

In 2012 the property was granted a 10' dimensional variance for front yard setback, a dimensional variance for the separation between the wetland edge and the OWTS and a special use permit for the construction of a single family house in a High Ground Water Sub-District A. Since then the town has aligned its requirement for the separation between an OWTS and a wetland edge to match that of the State's to 50'. This has eliminated the need for a dimensional variance.

This request is for a 10' dimensional variance from the front yard setback and for a special use permit to allow the construction of a single family dwelling in a High Ground Water Sub-district A.

Respectfully submitted,



Andrew Bilodeau Esq.
350 Division St #102
West Warwick, RI 02893
401-300-4055

NOTE: A LOCATION PLAN AND SKETCH AND DRAWINGS NECESSARY TO GIVE FULL INFORMATION MUST BE FILED WITH THE APPLICATION.

RI DEM OWTS Permit Search

DEM OWTS (Septic System) Permit Search (after 1990)

- One OWTS application matched your search criteria.

OWTS Application #9015-0061

Location:	Beach Avenue, Jamestown
Plat/Lot:	Plat 5 Lot 164
Owner Name:	Catanzaro, Bartholomew
Designer Name:	John Rockwell
Total Flow:	450
If your system was approved prior to 2008 calculate the number of bedrooms by dividing Total Flow by 150 gallons/bedroom. If your system was approved after 2008, divide Total Flow by 115 gallons/bedroom.	

Historical information

10-06-2019	Application Expiration Date
10-02-2019	Start of Construction
10-06-2018	Application Expiration Date
02-22-2013	Correspondence Received
02-14-2012	Application Expiration Date
02-15-2008	Approval Mailed
02-14-2008	Application Approved
02-14-2008	Review Application Resubmission
02-12-2008	Response to Unacceptable Received
05-18-2006	Unacceptable Form Mailed to Applicant
05-17-2006	Application Found Unacceptable
05-17-2006	Application Review
04-26-2006	New Building Construction App. Rec'd
11-21-2005	Variance Denial Mailed
11-18-2005	Variance Denied
11-16-2005	Variance Unacceptable Review
08-04-2005	Response to Variance Deficiency Received
06-17-2005	Variance Unacceptable Mailed
06-16-2005	Variance App. Returned Unacceptable
06-14-2005	Variance Unacceptable Review
04-18-2005	Response to Variance Deficiency Received
03-22-2005	

2/3/2020

RI.gov: DEM Onsite Wastewater Treatment Systems application search form

03-21-2005	Site Evaluation Approved
03-21-2005	Site Evaluation Form Review
03-18-2005	Soil Evaluation - CONCUR
03-17-2005	Site Evaluation Form Received
03-15-2005	Dry Season Inspection for Soil
02-11-2005	Dry Season Application Received
12-28-2004	Variance Unacceptable Mailed
12-24-2004	Variance App. Returned Unacceptable
12-22-2004	Variance Unacceptable Review
10-18-2004	Response to Variance Deficiency Received
07-19-2004	Variance Unacceptable Mailed
07-16-2004	Variance App. Returned Unacceptable
07-16-2004	Variance Application Review
05-06-2004	Variance Application Received
04-11-1995	WTV Verification Mailed
04-11-1995	Water Table Verified
04-11-1995	Water Table Verification Site Visit
03-01-1995	Water Table Verification Request Rcd.
09-28-1993	Unacceptable Form Mailed to Applicant
09-28-1993	Application Found Unacceptable
09-27-1993	Application Review
09-02-1993	New Building Construction App. Rec'd
08-16-1993	Unacceptable Form Mailed to Applicant
08-16-1993	Application Found Unacceptable
08-16-1993	Application Review
06-24-1993	Renewal Application Received
07-14-1992	Approval Mailed
07-14-1992	Application Approved
07-14-1992	Review Application Resubmission
06-22-1992	Response to Unacceptable Received

Last updated 01-31-2020 08:10 PM



DEM Wetlands Permit Application Search

DEM Wetland Application Search

1 application matched your search criteria.

DEM Wetland Application #11-0199

Applicant name	Catanzaro, Bartholomew
Organization name	
Location	Riptide Street Jamestown
Plat/Lot	Plat 5 / Lot 164
Project information	- Residential Lot (New)
Plan	View

Location description

approximately 30 feet east of Beach Avenue and approximately 30 feet south of the intersection with Riptide Street, Utility Pole No. 20, Assessor's Plat 5, Lot 164, Jamestown, RI

Historical information

January 23, 2012

Permit Recorded in Land Evidence Record

January 13, 2012

Insignificant Alteration Permit Issued

January 13, 2012

Application Review by Supervisor

January 11, 2012

Application Review by Biologist

December 20, 2011

Applicant Response to Tech. Deficiency

November 08, 2011

Technical Deficiency Letter Sent

November 08, 2011

Application Review by Biologist

October 20, 2011

Supervisor for Assignment

October 19, 2011

Preliminary Determination Application

For more information, you may call the DEM at 222-4700 or visit the DEM offices to set up an appointment to review this file or check on file availability for review. Office hours are Monday through Friday 8:30 AM to 4:00 PM. See <http://www.dem.ri.gov/directions/foundry-offices.php> for directions.

Search criteria



Office of the Town Planner MEMORANDUM

TO: Jamestown Zoning Board of Review
FROM: Lisa Bryer, AICP, Town Planner
RE: Motion for Zoning Section 82-314: High Groundwater Table and Impervious Overlay District, Sub-District A – Andrew Bilodeau: AP 5, Lot 164; Beach Avenue, Jamestown, RI
DATE: June 10, 2020

At the June 3, 2020 a Planning Commission meeting was held remotely by Zoom. At the meeting, the Planning Commission voted unanimously to recommend to the Jamestown Zoning Board, approval of the application of Andrew Bilodeau: AP 5, Lot 164; Beach Avenue, Jamestown, RI; being reviewed under Zoning Ordinance Section 314 - High Groundwater Table and Impervious Overlay District Sub-district A review in accordance with the plan entitled Development Plan Beach Ave Plat 5 Lot 164 Jamestown, RI, by RP Engineering, Inc., 121 Suffolk Drive, North Kingstown, RI 02852, 885-7255. The recommendation for approval is based on the following findings of facts as amended:

Findings of Fact Section 314

1. This site was previously reviewed and approved under the HGWT process in 2012;
2. Property is 21,600 sf in area;
3. The existing site is undeveloped;
4. The lot has OWTS approval RIDEM permit # 9015-0016;
5. Topography on the lot is flat;
6. There is a freshwater wetland wooded swamp (6038 sf) and its associated 50' perimeter wetland along the east side of the property;
7. Existing impervious cover is **0 sf or 0 %**;
8. Five (5) soil evaluations were conducted on the property. The results indicate an 18-inch seasonal high water table and 31" inches to category 9 soils. The site falls under **Sub-district "A"** requirements of the High Groundwater Table and Impervious Overlay District. The maximum impervious cover allowed is 10% (1556 sf);
9. The applicant is proposing to construct a 3-bedroom dwelling, a pervious driveway, OWTS and well;
10. The total proposed impervious cover proposed is **1530 sf**;
11. A new 3-bedroom advanced treatment OWTS (RIDEM permit #9015- 0016) is proposed;
12. For stormwater mitigation, a rain garden is proposed. The rooftop is directed toward a rain garden (with a bottom area of 576 sf);

13. The applicant's representative Richard Pastore, PE represented the applicant as an expert witness before the Planning Commission on 6-3-20;
14. The proposed impervious cover is **9.8%**, **1530 sf**. The maximum allowable impervious coverage for this site is 1556 sf;
15. The proposed BMP's provide treatment for the 1" water quality volume and provide storage for runoff from a 10-year frequency storm event for the proposed impervious surface on the site;
16. Jamestown Engineer Jean Lambert provided correspondence to Chris Costa, Building Official and Lisa Bryer, Town Planner dated February 24, 2020 regarding the Bilodeau application (attached) which notes that, the proposal, in her professional judgement, the requirements for development within 82-314 of the Zoning Ordinance have been met.

Recommended Conditions of Approval

1. A Special Use Permit for Section 314 is required from the Zoning Board of Review;
2. The proposed infiltration area and rain garden area must be physically delineated on the site prior to the commencement of construction to prevent compaction of the soil by heavy equipment;
3. An as-built plan should be provided at the completion of construction to the Building Official depicting the size and location of the house, size and location of the rain gardens, and verifying the elevations and grading shown on the proposed site plan;
4. The OWTS must be inspected and maintained as required by the Town Onsite Wastewater Management Program. A maintenance contract must be recorded in the land evidence records and a copy of the recorded document shall be submitted to the Planning Department; and,
5. The Operation and Maintenance (O & M) Plan (reproduced in 8.5" x 11" for the stormwater mitigation (rain gardens) shall be recorded in the Office of the Town Clerk with the Zoning Approval and evidence of such shall be provided to the Zoning Enforcement Officer as well as the Planning Department.
6. An erosion and sediment control permit will be required from the building official prior to commencement of construction. Erosion and sediment controls shall be installed at the down gradient limit of disturbance as shown on the site plans. Erosion controls shall be maintained until final stabilization is achieved on the site.

Attachments: 1) Memo from Jean Lambert, PE updated June 10, 2020 (accurate sf of rain garden)

2) A copy of the Application and Plan referenced above dated revised January 24, 2020



Town of Jamestown, Rhode Island

Engineering/GIS Office

93 Narragansett Ave ♦ Jamestown, RI 02835 – 1509

Date: June 10, 2020

To: Chris Costa, Building Official
Lisa Bryer, Town Planner

From: Jean Lambert, P.E.

RE: Zoning Section 82-314: High Groundwater Table and Impervious Overlay District, **Sub-District A**
Andrew Bilodeau: AP 5, Lot 164; Beach Avenue, Jamestown, RI

I have reviewed the site plan entitled, “Development Plan, Beach Ave, Plat 5 Lot 164, Jamestown RI” revision dated 2/14/2020 and prepared by RP Engineering, Inc. for the above referenced property. **In my professional judgement, the requirements for development within 82-314 Sub-District A have been met.** This site was previously reviewed and approved under the HGWT process in 2012.

Existing Site/Soil Information:

Property is 21,600 sf in area. The existing site is undeveloped. Topography on the lot is flat. There is a freshwater wetlands wooded swamp (6038 sf) and its associated 50’ perimeter wetland along the east side of the property. Existing impervious cover is approximately 0 sf.

Five (5) soil evaluations were conducted on the property. The results indicate an 18-inch seasonal high water table and 31” inches to category 9 soils. The site falls under **Sub-district “A”** requirements of the High Groundwater Table and Impervious Overlay District. The maximum impervious cover allowed is 10% (1556 sf).

Proposed Site:

The applicant is proposing to construct a 3-bedroom dwelling, a pervious driveway, OWTS and well. The total proposed impervious cover is 1530 sf. A new 3-bedroom advanced treatment OWTS (RIDEM permit #9015-0016) is proposed. For stormwater mitigation, a rain garden is proposed. The rooftop is directed toward a rain garden (with a bottom area of 576 sf).

Zoning Section 82-314 Review

Impervious Coverage & Stormwater Management:

The proposed impervious cover is 9.8%, 1530 sf. The maximum allowable impervious coverage for this site is 1556 sf. The proposed BMP’s provide treatment for the 1” water quality volume and provide storage for runoff from a 10-year frequency storm event for the proposed impervious surface on the site.

Recommendations/Conclusions:

- Rain garden maintenance requirements shall be recorded into the land evidence record.
- The proposed rain garden area shall be physically delineated on the site prior to the commencement of construction to prevent compaction of the soil.
- Erosion and sediment controls shall be installed at the downgradient limits of site disturbance as shown on the site plan prior to the commencement of construction.

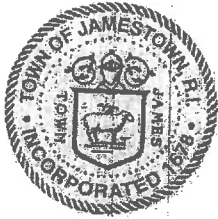

Application Form

Jamestown Zoning Section 314 High Ground Water Table and Impervious Layer Overlay District

SECTION I: GENERAL INFORMATION

PROPERTY OWNER: ANDREW BILODIANU ESQ TELEPHONE: 401 300 4055

MAILING ADDRESS: 1350 DIVISION RD # 102
WEST WARWICK, RI 02893

SITE LOCATION: BROAD AVE x RIPTIDE ST (STREET)

PLAT: 5 LOT: 164 LOT AREA: 21600 SF

PROJECT DESCRIPTION: CONSTRUCT SINGLE FAMILY RESIDENCE

SECTION II: SOIL INFORMATION

CLASS IV SOIL EVALUATOR:

NAME: P SUDESA RIDEM LICENSE #: 4049 TELEPHONE: _____

NUMBER OF SOIL EVALUATIONS: 5 (ATTACH ALL SOIL EVALUATIONS (IN PROPT FILES))

DEPTH TO SEASONAL HIGH GROUNDWATER TABLE (IN INCHES): 24"

DEPTH TO CATEGORY 9 SOILS (IN INCHES): 31"

OFFICE ONLY: SUB-DISTRICT CLASSIFICATION: (A) or B

SECTION III: OWTS INFORMATION

TYPE OF OWTS: BSF RIDEM PERMIT #: 9015-0016

DISTANCE BETWEEN THE WELL AND LEACHFIELD: 115'

OWTS AND WELL LOCATED ON THE SAME LOT AS THE STRUCTURE IT SERVES? (Y) OR N

SECTION IV: SITE INFORMATION

TYPE OF STORMWATER CONTROL SYSTEM: RAIN GARDENS

TOTAL BUILDABLE AREA (TOTAL LOT AREA - WETLAND AREA): 21600 - 6038 = 15562 sf

PROPOSED IMPERVIOUS AREA: 2220 sf

% IMPERVIOUS COVERAGE ALLOWED: 15%

% IMPERVIOUS COVERAGE PROPOSED: 14.27
(AREA IMPERVIOUS / TOTAL BUILDABLE AREA)

SECTION V: CONTACT INFORMATION

OWTS DESIGNER:

NAME: Peter Swessa PLS RIDEM LICENSE #: 2016

ADDRESS: COUNTRY SURVEY
46 SOUTH MAIN ST, COUNTRY, RI 02816

SIGNATURE: ON FILE DATE: _____

TELEPHONE: 823-5028 EMAIL: _____

STORMWATER SYSTEM DESIGNER:

NAME: RICHARD PASTORE P.E. STATE LICENSE #: 5815

ADDRESS: 121 SUFFOLK DR
NORTH KINGSTOWN, RI 02852

SIGNATURE: [Signature] DATE: 1/23/20

TELEPHONE: 885 7255 EMAIL: RPUNGRI@GMAIL.COM

APPLICANT CONTACT INFORMATION:

NAME: SEE OWNER INFO

ADDRESS: _____

SIGNATURE: [Signature] DATE: 1/30/20

TELEPHONE: 401 300 4055 EMAIL: ABALORDAU@BALORDAUCAPALSO.COM

SUBMISSION REQUIREMENTS

Submit one copy of the following items for preliminary review. Applicant will be notified when additional copies are required for Planning Board review.

- Application Form
- Site Plan
- Soil Evaluations (include all results for site) IN PLANNING DEPT FILE
- Stormwater Analysis
- Project Narrative
- Proposed Building Floor Plans (if applicable)
- Approved RIDEM OWTS permit IN PLANNING DEPT FILE
- O&M Requirements for Stormwater Mitigation

Contact Jean Lambert at 423-7193 or jlambert@jamestownri.net with questions regarding HGWT applications.

THESE ARE ONLY PLANTS APPROVED FOR RAIN GARDENS DUE TO "FILTER"

RHODE ISLAND COASTAL PLANT GUIDE

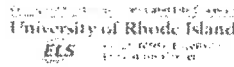

RAIN GARDEN FILTER "EN"

37 of 231 Species Page 1 of 1 Clear Filter Help | About the Coastal Plant Guide

Enter all or part of name above to filter list (Select from dropdown list to filter plants by attributes)

Species	Common Name	Zone	Plant Type	Native Status	Ful Status	Shade Tolerant	Drought Tolerant	Wet Sites Tolerant	And Tolerant	Na.Spray Tolerant	Na.Soil Tolerant	Acid Tolerant	pH Adapt	Re Gardens	Dure Plant	Height	Width	Availability
<i>Amelanchier arborea</i> l	Serviceberry	1	Tree	+	+	+	+	-	+	-	+	-	+	-	-	>10'	15-25'	10,67,74,57
<i>Amelanchier canadensis</i> l	Shadbush	1	Shrub	+	+	+	+	+	+	+	+	+	+	+	+	>10'	variable	8,10,22,52,74,77,100,57
<i>Amelanchier laevis</i> l	Allegheny Serviceberry	1	Tree	+	+	+	+	-	+	+	+	+	+	-	-	>10'	15-25'	8,10,67,74,77,57
<i>Arctostaphylos uva-ursi</i> l	Bearberry	1	Shrub	+	+	+	+	-	+	+	+	-	+	-	-	<2'	variable	8,10,22,24,41,52,67,74,77,100
<i>Asclepias tuberosa</i>	Butterfly Milkweed	2	Per.	+	+	-	+	-	-	-	-	-	+	-	-	2-6'	2'	8,10,12,22,24,67,74,77
<i>Astilbe sp.</i>	Astilbe	2	Per.	-	+	+	-	-	-	-	-	-	+	-	-	2-6'		2,8,10,12,22,24,67,74,77,35,51
<i>Carex stricta</i>	Tussock Sedge	2	Grass	+	+	+	+	+	-	-	+	-	+	-	-	<2'	1.5-2'	10,12,22,24,35,67,74
<i>Cephalanthus occidentalis</i>	Common Buttonbush	1	Shrub	+	+	+	-	+	+	-	+	-	+	-	-	2-6'	3-6'	8,10,52,74,77,100
<i>Clethra alnifolia</i>	Sweet Pepperbush	1	Shrub	+	+	+	+	+	+	+	+	+	+	+	-	6-10'	4-6'	8,10,22,24,41,52,67,74,77,100,51,81
<i>Comptonia peregrina</i>	Sweet Fern	2	Shrub	+	+	+	+	+	+	-	+	-	+	-	-	2-6'	4-8'	10,52,74,77,100,57
<i>Cornus amomum</i> l	Silky Dogwood	1	Shrub	+	+	+	+	+	+	-	+	-	+	-	-	6-10'	6-10'	8,10,22,52,74,100,57
<i>Cornus racemosa</i> l	Gray Dogwood	1	Shrub	+	+	+	+	+	+	+	+	+	+	-	-	6-10'	variable	8,10,22,52,67,74,100,57
<i>Cornus sericea</i> l	Redosier Dogwood	1	Shrub	+	+	+	+	+	+	+	+	+	+	-	-	6-10'	7-9'	8,10,22,52,67,74,100,57
<i>Eupatoriadelphus dubius</i>	Coastal Plain Joe Pye Weed	2	Per.	+	+	-	-	+	-	-	-	-	+	-	-	2-6'	2-3'	12,67
<i>Eupatoriadelphus maculatus</i>	Spotted Trumpetweed	2	Per.	+	+	-	-	+	-	-	-	-	+	-	-	2-6'		10,67
<i>Eupatorium perfoliatum</i>	Boneset	2	Per.	+	+	-	-	+	-	-	-	-	+	-	-	2-6'	3-4'	10,12,67,74,77,100
<i>Eupatorium purpureum</i>	Joe Pye Weed	1	Per.	+	+	-	+	+	+	+	+	+	+	-	-	2-6'	3'	2,10,12,22,24,67,74,77,100
<i>Hamamelis vernalis</i>	Vernal Witchhazel	1	Shrub	-	+	+	+	+	+	-	-	+	+	-	-	6-10'	6-10'	2,8,10,22,52,74,77,57
<i>Hibiscus moscheutos</i>	Rose Mallow	2	Per.	+	+	-	-	+	+	+	+	+	+	-	-	6-10'	3-5'	2,8,10,12,22,24,67,74,77,35
<i>Ilex glabra</i>	Inkberry Holly	1	Shrub	+	+	+	+	+	+	+	+	+	+	-	-	6-10'	8-10'	2,8,10,22,24,52,67,74,77,51,81
<i>Ilex opaca</i>	American Holly	2	Tree	+	+	+	+	+	-	-	+	-	+	-	-	>10'	15-30'	2,10,22,24,67,74,77,57
<i>Ilex verticillata</i> l	Winterberry Holly	1	Shrub	+	+	+	+	+	+	+	+	+	+	-	-	6-10'	6-10'	2,8,10,22,24,41,52,67,77,100,57
<i>Iris versicolor</i>	Blue Flag	2	Per.	+	+	+	-	+	-	-	-	-	+	-	-	2-6'	1-2'	2,10,12,22,24,51,67,74,77,100
<i>Kalmia latifolia</i>	Mountain Laurel	2	Shrub	+	-	+	+	-	-	-	+	+	+	-	-	>10'	5-12'	2,10,22,24,52,56,67,74,77,100,57
<i>Ledum groenlandicum</i>	Labrador Tea	2	Shrub	+	+	+	-	+	-	-	+	-	+	-	-	2-6'	2-4'	67
<i>Lindera benzoin</i> l	Spicebush	2	Shrub	+	+	+	-	+	-	-	+	-	+	-	-	>10'	-	2,8,10,52,67,74,77,100
<i>Morella (Myrica) pennsylvanica</i> l	Bayberry	1	Shrub	+	+	+	+	-	+	+	+	-	+	+	-	>10'	5-12'	2,8,10,22,52,67,74,77,57
<i>Panicum virgatum</i>	Sw tchgrass	1	Grass	+	+	-	+	-	+	-	+	-	+	+	-	6-10'	2-3'	28,10,12,22,24,51,52,67,74,77,100
<i>Photinia melanocarpa</i>	Black Chokeberry	1	Shrub	+	+	+	+	+	+	+	+	-	+	-	-	2-6'	10'	52,67,74,100
<i>Photinia pyrifolia</i>	Red Chokeberry	1	Shrub	+	+	+	+	+	+	+	+	-	+	-	-	>10'	5'	52,67,100
<i>Rhododendron viscosum</i>	Swamp Azalea	2	Shrub	+	-	+	+	+	-	-	+	-	+	-	-	6-10'	3-8'	8,10,24,52,67,74,77
<i>Rhus copallinum</i>	Winged Sumac	1	Shrub	-	+	+	+	+	+	+	+	+	+	+	-	>10'	20-30'	8,10,74
<i>Rudbeckia fulgida</i> 'Goldstrum'	Orange Coneflower	2	Per.	-	+	-	+	-	-	-	-	-	+	-	-	2-6'	1.5-2'	2,8,10,12,22,24,67,74,77,35
<i>Symphoricarpos novae-angliae</i>	New England Aster	2	Per.	+	+	-	+	-	+	-	-	-	+	-	-	2-6'	4'	2,10,12,22,24,67,74,77,100,35
<i>Vaccinium corymbosum</i> l	Highbush Blueberry	1	Shrub	+	+	+	+	+	+	+	+	-	+	-	-	>10'	8-12'	2,8,10,22,24,52,67,74,77,100,57
<i>Vernonia noveboracensis</i>	New York Ironweed	2	Per.	+	+	-	+	-	-	-	-	-	+	-	-	2-6'	2-3'	12,22,67,74,100
	Arrowwood	1	Shrub	+	+	+	+	+	+	+	+	+	+	-	-	>10'	6-15'	2,8,10,22,24,41,52,67,74,77,51,81,100

RI DEM OWTS Permit Search

DEM OWTS (Septic System) Permit Search (after 1990)

- One OWTS application matched your search criteria.

OWTS Application #9015-0061

Location: Beach Avenue, Jamestown

Plat/Lot: Plat 5 Lot 164

Owner Name: Catanzaro, Bartholomew

Designer Name: John Rockwell

Total Flow: 450

If your system was approved prior to 2008 calculate the number of bedrooms by dividing Total Flow by 150 gallons/bedroom. If your system was approved after 2008, divide Total Flow by 115 gallons/bedroom.

Historical information

10-06-2019	Application Expiration Date
10-02-2019	Start of Construction
10-06-2018	Application Expiration Date
02-22-2013	Correspondence Received
02-14-2012	Application Expiration Date
02-15-2008	Approval Mailed
02-14-2008	Application Approved
02-14-2008	Review Application Resubmission
02-12-2008	Response to Unacceptable Received
05-18-2006	Unacceptable Form Mailed to Applicant
05-17-2006	Application Found Unacceptable
05-17-2006	Application Review
04-26-2006	New Building Construction App. Rec'd
11-21-2005	Variance Denial Mailed
11-18-2005	Variance Denied
11-16-2005	Variance Unacceptable Review
08-04-2005	Response to Variance Deficiency Received
06-17-2005	Variance Unacceptable Mailed
06-16-2005	Variance App. Returned Unacceptable
06-14-2005	Variance Unacceptable Review
04-18-2005	Response to Variance Deficiency Received
03-23-2005	Site Evaluation Report Mailed

03-21-2005	Site Evaluation Approved
03-21-2005	Site Evaluation Form Review
03-18-2005	Soil Evaluation - CONCUR
03-17-2005	Site Evaluation Form Received
03-15-2005	Dry Season Inspection for Soil
02-11-2005	Dry Season Application Received
12-28-2004	Variance Unacceptable Mailed
12-24-2004	Variance App. Returned Unacceptable
12-22-2004	Variance Unacceptable Review
10-18-2004	Response to Variance Deficiency Received
07-19-2004	Variance Unacceptable Mailed
07-16-2004	Variance App. Returned Unacceptable
07-16-2004	Variance Application Review
05-06-2004	Variance Application Received
04-11-1995	WTV Verification Mailed
04-11-1995	Water Table Verified
04-11-1995	Water Table Verification Site Visit
03-01-1995	Water Table Verification Request Rcd.
09-28-1993	Unacceptable Form Mailed to Applicant
09-28-1993	Application Found Unacceptable
09-27-1993	Application Review
09-02-1993	New Building Construction App. Rec'd
08-16-1993	Unacceptable Form Mailed to Applicant
08-16-1993	Application Found Unacceptable
08-16-1993	Application Review
06-24-1993	Renewal Application Received
07-14-1992	Approval Mailed
07-14-1992	Application Approved
07-14-1992	Review Application Resubmission
06-22-1992	Response to Unacceptable Received

Last updated 01-31-2020 08:10 PM



DEM Wetlands Permit Application Search

DEM Wetland Application Search

1 application matched your search criteria.

DEM Wetland Application #11-0199

<i>Applicant name</i>	Catanzaro, Bartholomew
<i>Organization name</i>	
<i>Location</i>	Riptide Street Jamestown
<i>Plat/Lot</i>	Plat 5 / Lot 164
<i>Project information</i>	- Residential Lot (New)
<i>Plan</i>	View

Location description

approximately 30 feet east of Beach Avenue and approximately 30 feet south of the intersection with Riptide Street, Utility Pole No. 20, Assessor's Plat 5, Lot 164, Jamestown, RI

Historical information

January 23, 2012

Permit Recorded in Land Evidence Record

January 13, 2012

Insignificant Alteration Permit Issued

January 13, 2012

Application Review by Supervisor

January 11, 2012

Application Review by Biologist

December 20, 2011

Applicant Response to Tech. Deficiency

November 08, 2011

Technical Deficiency Letter Sent

November 08, 2011

Application Review by Biologist

October 20, 2011

Supervisor for Assignment

October 19, 2011

Preliminary Determination Application

For more information, you may call the DEM at 222-4700 or visit the DEM offices to set up an appointment to review this file or check on file availability for review. Office hours are Monday through Friday 8:30 AM to 4:00 PM. See <http://www.dem.ri.gov/directions/foundry-offices.php> for directions.

Search criteria

Application #

RAIN GARDEN O& M PLAN
BEACH AVE
PLAT 5 LOT 164
JAMESTOWN, RI

1. Rain gardens shall be inspected following at least the first two precipitation events of at least 1.0" to ensure that the system is functioning properly. Thereafter, it shall be monitored and maintained to insure proper functioning, plant growth and survival. Plants shall be replaced on an as-needed basis during the growing season.

2. Silt/sediment shall be removed from the rain garden when the accumulation exceeds one inch or when water ponds on the surface for more than 48 hours. The top few inches of material shall be removed and replaced with fresh soil mixture and mulch.

3. Pruning or replacement of woody vegetation shall occur when dead or dying vegetation is observed.

4. Soil erosion gullies shall be repaired when they occur.

5. Fertilizer or pesticides shall not be applied to plants within rain gardens.

Perennial plants and ground covers shall be replaced as necessary to maintain an adequate vegetated ground cover. Annual plants may also be used to maintain ground cover.



DEPARTMENT OF ENVIRONMENTAL MANAGEMENT
INDIVIDUAL SEWAGE DISPOSAL SYSTEM APPLICATION

APPLICATION No. 9015-0061

FOR DEM USE ONLY

DATE RECEIVED 4/11/04

CHECK IF APPLICABLE

- NEW BUILDING CONSTRUCTION
- ALTERATION
- REPAIR
- TRANSFER

I/A TECHNOLOGY ADVANTAGE w/
TYPE OF SYSTEM BOTTOMLESS SAND FILTER
 VARIANCE

AMOUNT RECEIVED \$ 100

CHECK # 119 COST CODE 0

CERTIFICATION

PETER SUKORSA (print), the undersigned licensed ISDS designer, certifies that prepared this application and accompanying forms, submittals, plans and sketches in accordance with the rules and regulations of the Rhode Island Department of Environmental Management pertaining to individual sewage disposal systems and that all the information provided on this application and accompanying forms, submittals, plans and sketches is true and accurate.

SITE INFORMATION

BEACH AVENUE CITY/TOWN JAMPSTOWN POLE # 20
NO. STREET
PLAT NUMBER 5 LOT NUMBER 164 SUBDIVISION LOT NUMBER N.A.
LOT SIZE 1600 SQUARE FEET
SUBDIVISION NAME NONE
PRELIMINARY, SUBDIVISION SUITABILITY # 1

OWNER INFORMATION

CATANZARO FIRST NAME BARTOLOMEO M.I. ROSE
LAST NAME
3 WOODCROFT DRIVE CITY/TOWN JOHNSTON ZIP CODE 02919
NO. STREET

DEM APPLICATION HISTORY

PREVIOUS WATER TABLE/SDS # YES NO APPLICATION # 9015-0061
DEPTH TO VERIFIED WATER TABLE 2' How Determined Soil EXCAVATION

TEST HOLE # 2 DATE EXCAVATED 3/15/05 WETLANDS WITHIN 200' OF ISDS YES NO
WETLAND PERMIT YES NO PERMIT # 03-0564 DATE OF APPROVAL 1/19/04

Groundwater Quality Certification attached? YES NO (Required for a system \geq 10,000 gpd.)

DESIGN INFORMATION

BUILDING USE: Residential Commercial Other
WATER SUPPLY: public water public well private well
OF DESIGN UNITS 3-PR
UNIT DESIGN FLOW 15 gallons per minute (unit) TOTAL DAILY FLOW 450 gallons
TANK SIZE 1500 gallons DESIGN PERCOLATION RATE 15 minutes/inch
MINIMUM REQUIRED LEACHFIELD AREA 30 square feet
LEACHFIELD TYPE 30 SQUARE FEET
TOTAL AREA OF LEACHFIELD PROVIDED 30 SQUARE FEET

Signature of Designer Peter Sukorsa
Designer License Number D 2016 Phone # 823-5078
Business/Company Name CAENNY SERVICES CO INC

I certify that: a) I am the owner of the property indicated under site information on this application, b) I will hire a licensed ISDS installer to install the system proposed herein, c) the system will be installed in strict accordance with this application, d) I will hire and retain the licensed ISDS designer of record to witness and inspect the installation of the system, e) I assume all responsibility for the truth and accuracy of this application and all liability and responsibility for any improper installations of the system on this site and agree to hold the Department of Environmental Management harmless from any, and all claims relating whatsoever to the system.

Owner(s) Signature [Signature] Phone Number 412-31-5271

PERMIT APPROVAL SECTION
TO BE COMPLETED BY A DEM OFFICIAL; DO NOT WRITE BELOW THIS LINE

Based upon the representations of the owner, and the owner's agents, including the representatives of the owner's licensed ISDS designer, this application for an individual sewage disposal system is hereby approved based upon the truth and accuracy of all information submitted. The Department of Environmental Management assumes no responsibility or liability for the future safe operation or maintenance of the aforesaid system, or the fitness or suitability of this system to this site, nor does it assume any responsibility for the accuracy and truth of the owner's or the owner's agents' representations. This approval is subject to future suspension and revocation in the event that subsequent examination reveals any data indicated on any application, form, submitted plan or sketch to be incorrect, or in compliance with the requirements or any condition of this site are such that the approved design is not in accordance with the requirements or in the event that the system discharges sewage on or to the ground surface, or on to any watercourse or fails to operate satisfactorily in any other manner.

- IMPORTANT: Please note the circled additional terms of approval:
- A. Designer of record must witness and inspect all stages of construction and must submit a certificate of construction in accordance with SD27.00.
 - B. Designer of record must contact DEM 24 hours before start of construction.
 - C. Bottom of leaching area excavation must be inspected by the DEM prior to placement of any gravel or stone.
 - D. System installation must be inspected by DEM prior to covering any component of the system with backfill.
 - E. Approved per variance decision dated 1/19/04, all requirements, conditions and stipulations of which shall be strictly adhered to.
 - F. I/A Technology: additional specific installation, operation, or maintenance requirements may apply (see DEM I/A Technology certification for this system type).
 - G. Proper erosion and sedimentation controls must be installed prior to the start of construction.
 - H. Other See attached variance decision

Signature of Department of Environmental Management Official [Signature]
Date of Approval 4/11/04
Date of Expiration 3/31/05

APR 21 2004



STATE OF RHODE ISLAND AND PROVIDENCE PLANTATIONS
 Department of Environmental Management
 Office of Water Resources



Site Evaluation Form

Part A - Soil Profile Description

Application Number 9015-0061

Property Owner: BARTHOLOMEW CATANZARO

Property Location: OPPOSITE PLE #20 BEACH AVENUE JAMESTOWN

Date of Test Hole: MARCH 15, 2005

Soil Evaluator: PETER SUORSA

License Number: D4049

Weather: MOSTLY SUNNY 40°

Shaded: Yes No Time: 11:00 AM

M # / Horizon	Depth	Horizon Boundaries		Soil Colors		Re-Dox Description			Texture	Structure	Consistence	Soil Category
		Dist	Topo	Matrix	Re-Dox Features	Ab.	S.	Con.				
AP	0" - 7"	C	S	10YR 3/2	-	-	-	-	fsl	fine gran	fr	3
Bw1	7" - 20"	g	S	2.5Y 4/3	-	-	-	-	fsl	fine l-sbk	fr	3
Bw2	20" - 34"	a	W	2.5Y 4/4	7.5YR 5/8	c	m	d	fsl	med. l-sbk	fr	3
2Cdg	34" - 78"	-	-	2.5Y 4/1	7.5YR 5/8	c	m	d	sil	o-m	fi	9
M # 2 / Horizon	Depth	Horizon Boundaries		Soil Colors		Re-Dox Description			Texture	Structure	Consistence	Soil Category
		Dist	Topo	Matrix	Re-Dox Features	Ab.	S.	Con.				
AP	0" - 6"	g	S	10YR 3/2	-	-	-	-	fsl	fine gran	fr	3
Bw1	6" - 19"	C	W	2.5Y 4/3	-	-	-	-	fsl	fine l-sbk	fr	3
Bw2	19" - 32"	a	W	2.5Y 5/4	7.5YR 5/8	c	m	d	sl	fine l-sbk	fr	3
2Cdg	32" - 68"	-	-	2.5Y 4/1	-	-	-	-	sil	o-m	fi	9

Soil Class: BASAL TILL / DENSE TILL
 Depth to Groundwater Seepage: #1 - 64" #2 - 62"
 Estimated Seasonal High Water Table: #1 - 24" #2 - 24"

Total Depth of each Test Hole: #1 - #2
 Depth to Impervious or Limiting Layer: #1 - #2 - NONE OBSERVED
 Comments:



STATE OF RHODE ISLAND AND PROVIDENCE PLANTATIONS
 Department of Environmental Management
 Office of Water Resources



Site Evaluation Form

Part A - Soil Profile Description

Application Number 9015-0061

Property Owner: BARTHOLOMEW CATANZARO RATS Lot 164

Property Location: OPP. POLE #20 BEACH AVENUE JAMESTOWN

Date of Test Hole: MARCH 15, 2005

Soil Evaluator: PETER SUORSA License Number: D4049

Weather: Mostly Sunny 40° Shaded: Yes No Time: 11:00 AM

M #3 Horizon	Depth	Horizon Boundaries		Soil Colors		Re-Dox Description			Texture	Structure	Consistence	Soil Category
		Dist	Topo	Matrix	Re-Dox Features	Ab.	S.	Con.				
AP	0"-6"	C	S	10YR 3/3	-	-	-	-	fsl	fine gran.	fr.	3
Bw1	6"-18"	g	S	2.5Y 4/2	-	-	-	-	fsl	fine l-sbk	fr.	3
Bw2	18"-31"	a	W	2.5Y 4/3	7.5YR 5/8	f	m	d.	fsl	med. l-sbk	fr.	3
2Cdg	31"-64"	-	-	2.5Y 4/1	-	-	-	-	sil	0-M	fi.	9
M #4 Horizon	Depth	Horizon Boundaries		Soil Colors		Re-Dox Description			Texture	Structure	Consistence	Soil Category
		Dist	Topo	Matrix	Re-Dox Features	Ab.	S.	Con.				
AP	0"-5"	C	S	10YR 3/3	-	-	-	-	fsl	fine gran.	fr.	3
Bw1	5"-13"	g	S	2.5Y 4/3	-	-	-	-	fsl	fine l-sbk	fr.	3
Bw2	13"-38"	a	W	2.5Y 5/4	7.5YR 5/8	f	m	d.	sl	fine l-sbk	fr.	3
2Cdg	38"-72"	-	-	2.5Y 4/1	-	-	-	-	sil	0-M	fi.	9

Soil Class: DENSE TILL
 Depth to Groundwater Seepage: #3-60" #4-47"
 Estimated Seasonal High Water Table: #3-24" #4-24"

Total Depth of each Test Hole: #3-78" #4-105"
 Depth to Impervious or Limiting Layer: #3-78" #4-90"
 Comments: _____



STATE OF RHODE ISLAND AND PROVIDENCE PLANTATIONS

Department of Environmental Management

Office of Water Resources

MAR 17 2005



Site Evaluation Form

Part A - Soil Profile Description

Application Number 9015-0061

Property Owner: BARTHOLOMEW CATANZARO Plot 5 Lot 164

Property Location: OFF Rte #20 BEACH AVENUE JAMESTOWN

Date of Test Hole: MARCH 15, 2005

Soil Evaluator: PETER SUORSA

License Number: D4049

Weather: MOSTLY SUNNY 40°

Shaded: Yes [X] No [] Time: 11:00 AM

M1 #5 Horizon	Depth	Horizon Boundaries		Soil Colors		Re-Dox Description			Texture	Structure	Consistence	Soil Category
		Dist	Topo	Matrix	Re-Dox Features	Ab.	S.	Con.				
AP	0"-9"	C	S	10YR 3/3	-	-	-	-	fsl	fine gr.	fr.	3
Bw1	9"-34"	a	b	2.5Y 4/2	-	-	-	-	fsl	fine l-sbk	fr.	3
B/C	34"-46"	a	w	2.5Y4/2 2.5Y4/1	7.5YR 5/8	f	m	d	fsl fsl	fine l-sbk	fr.	3/9
2Cdg	46"-72"	-	-	2.5Y 4/1	-	-	-	-	sil	o-m	fi.	9

Soil Class: DENSE TILL
Depth to Groundwater Seepage: 5-32"
Estimated Seasonal High Water Table: 5-18"

Total Depth of each Test Hole: 5-84"
Depth to Impervious or Limiting Layer: 5-84"
Comments:

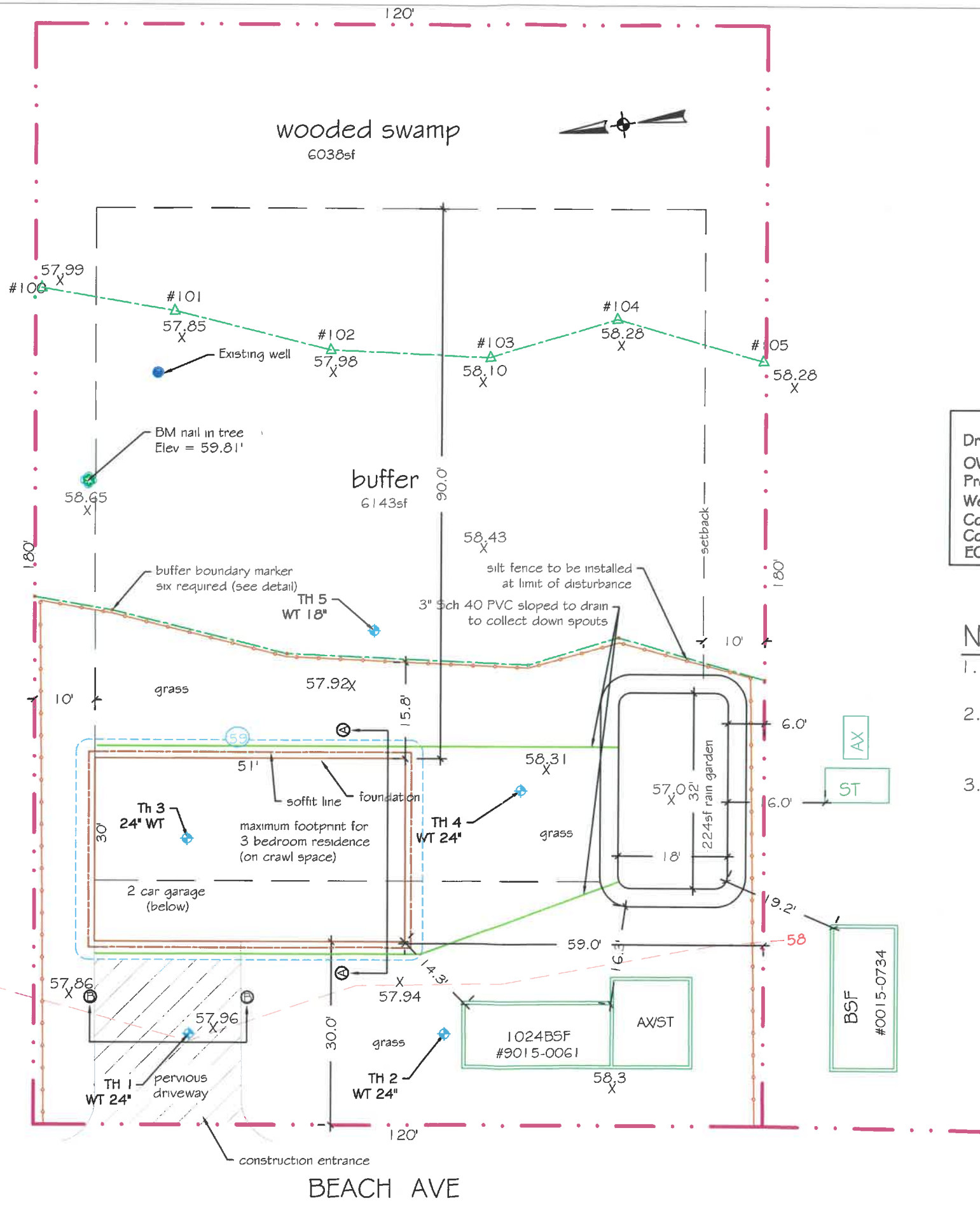

KEY

- Driveway
- OWTS
- Prop Line
- Wells
- Contour Proposed
- Contour Existing
- EOP

Notes:

1. Wetlands flagging by Applied Bio Systems
P.O. Box 985 West Kingston, RI 02892
2. The information show on this plan was obtained by an on-site survey. Site plan and Class III survey by Coventry Survey
3. Wetlands Permit # 11-0199 (expires July 1, 2020)



Andrew Bilodeau, Esq.
1350 Division Rd # 102
West Warwick, RI

Plat/Lot: 5/164

REVISIONS
2/7/20
2/14/20

DEVELOPMENT PLAN
BEACH AVE PLAT 5 LOT 164
JAMESTOWN, RI

RP Engineering, Inc.
121 Suffolk Drive
North Kingstown, RI 02852
885-7255 (1050 fax)

Scale - 1"=20'
Sheet - 1

1/27/20

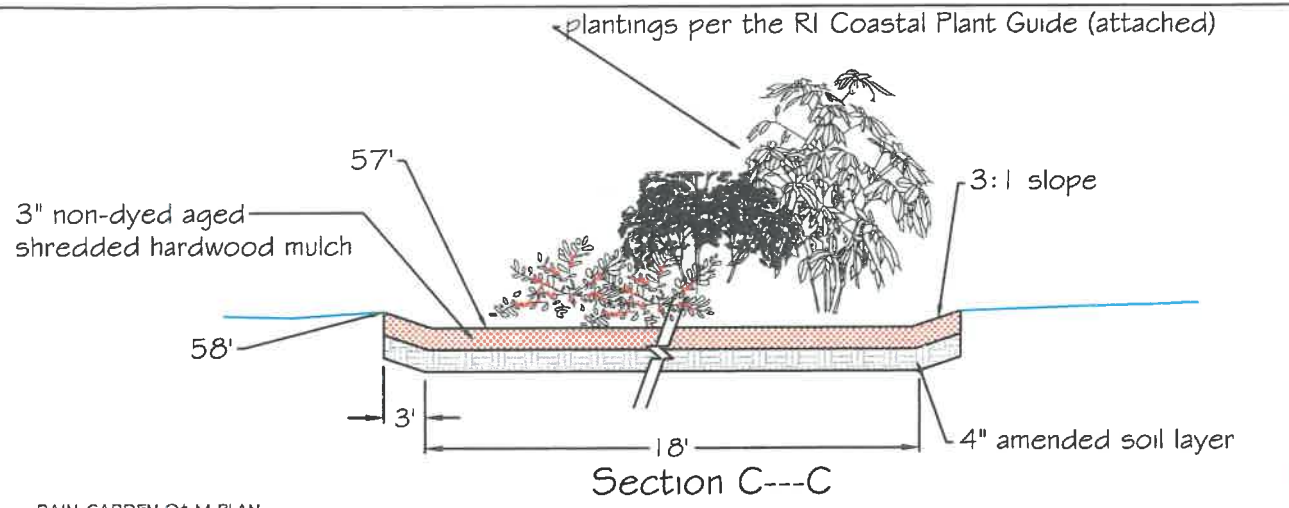

Section C---C

RAIN GARDEN O&M PLAN

1. Rain gardens shall be inspected following at least the first two precipitation events of at least 1.0" to ensure that the system is functioning properly. Thereafter, it shall be monitored and maintained to insure proper functioning, plant growth and survival. Plants shall be replaced on an as-needed basis during the growing season.
2. Silt/sediment shall be removed from the rain garden when the accumulation exceeds one inch or when water ponds on the surface for more than 48 hours. The top few inches of material shall be removed and replaced with fresh soil mixture and mulch.
3. Pruning or replacement of woody vegetation shall occur when dead or dying vegetation is observed.
4. Soil erosion gullies shall be repaired when they occur.
5. Fertilizer or pesticides shall not be applied to plants within rain gardens. Perennial plants and ground covers shall be replaced as necessary to maintain an adequate vegetated ground cover. Annual plants may also be used to maintain ground cover.

%COVERAGE
 HOUSE = 51x30=1530sf
 LOT AREA = 21600sf
 Wetland area = 6038sf
 Buildable area = 15562sf
 % COVERAGE = 10% (1556sf)

SETBACKS
 Front & Rear - 40'
 Side - 10'

21600 lot area
 -6038 swamp
 15562
 -6143 buffer
 9419 remaining buildable
 -1550 (31x50) foundation
 7869 grass

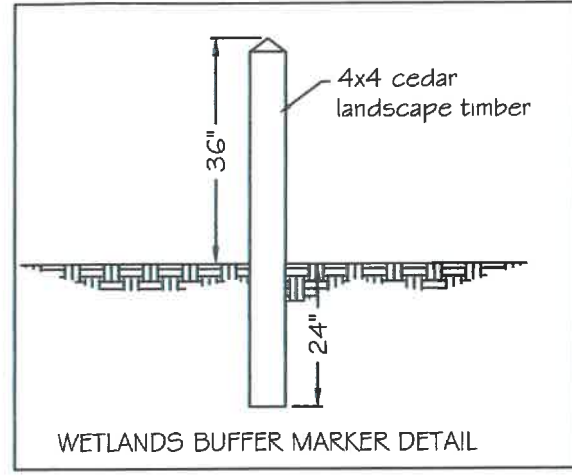

WETLANDS BUFFER MARKER DETAIL

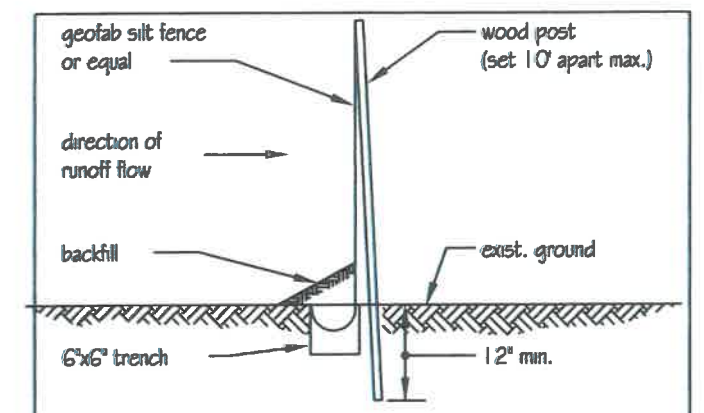

SILT FENCE DETAIL
 NOT TO SCALE

INSTALLATION SEQUENCING:

1. Dig trench 6" deep.
2. Set fence post 10' apart max. At slight Angle toward runoff direction.
3. Attach geofab to post.
4. Lower 6" of geofab in trench curled Toward runoff direction & backfill.
5. Fence to be installed as indicated on the

Drainage Calculations:
 Pre development = 21600sf x (4.9"/12 ppt)(.15) = 1323cf
 Post development = roof 53x32 = 1696 (includes 12" soffit): (1696sf)(4.9"/12)(.95) = 658cf
 grass: (7869)(4.9"/12)(.15) = 482cf
 wetland: (6038)(4.9"/12)(.15) = 370cf
 buffer: (6143)(4.9"/12)(.15) = 376cf
 Post Dev sub total = 1886cf
 RO to be contained = 1886-1323=563cf
 Rain garden = 32'x18'x12"=576cf

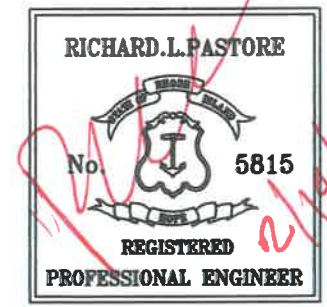

Andrew Bilodeau, Esq.
 1350 Division Rd # 102
 West Warwick, RI

Plat/Lot: 5/164

**DEVELOPMENT PLAN/
 DRAINAGE DETAILS
 BEACH AVE PLAT 5 LOT 164
 JAMESTOWN, RI**

REVISIONS
 2/7/20

RP Engineering, Inc.
 121 Suffolk Drive
 North Kingstown, RI 02852
 885-7255 (1050 fax)

Scale - NTS
 Sheet - 2

1/23/20

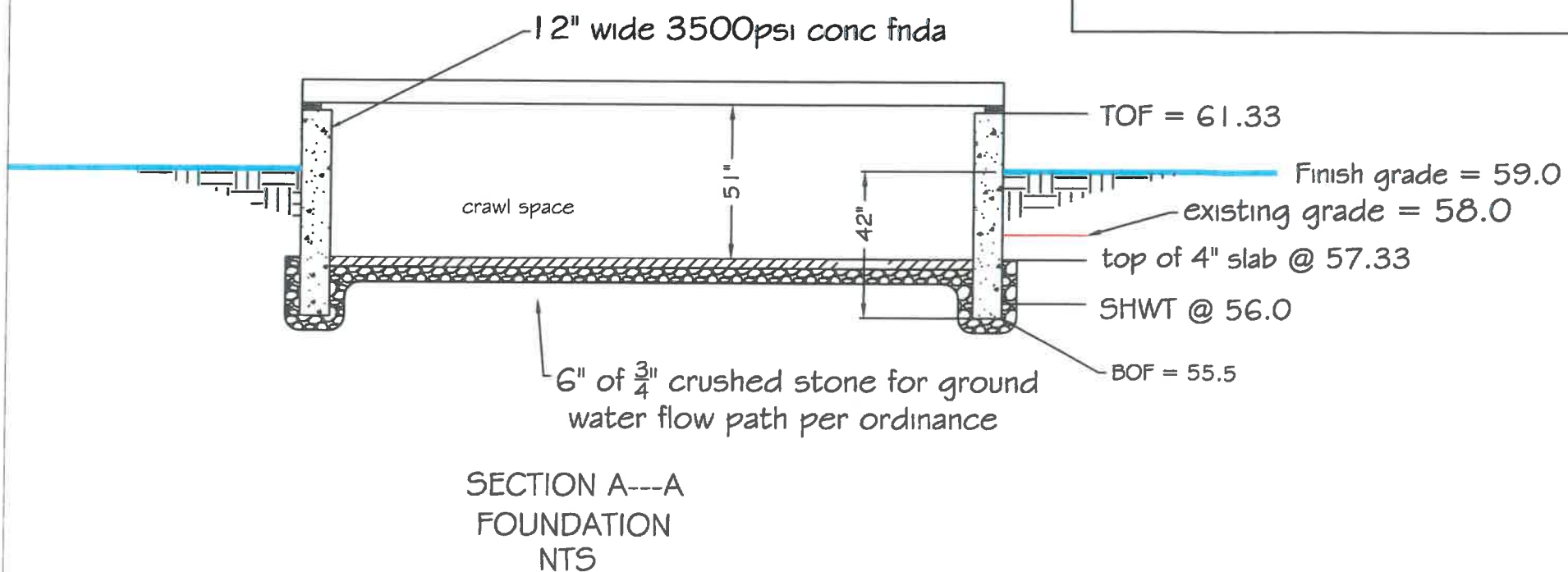
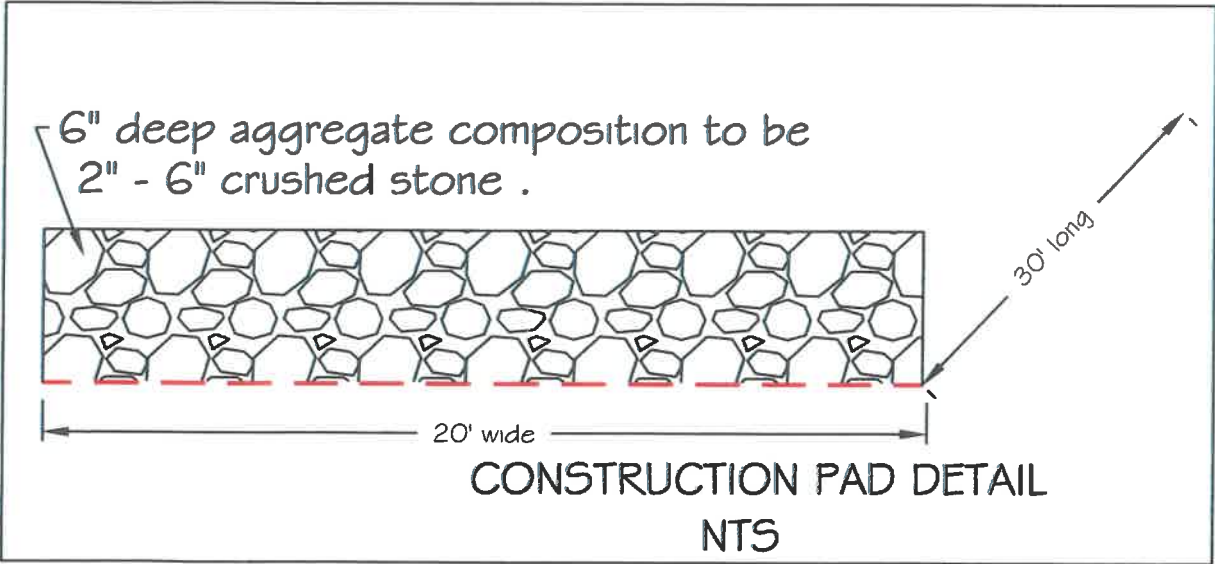
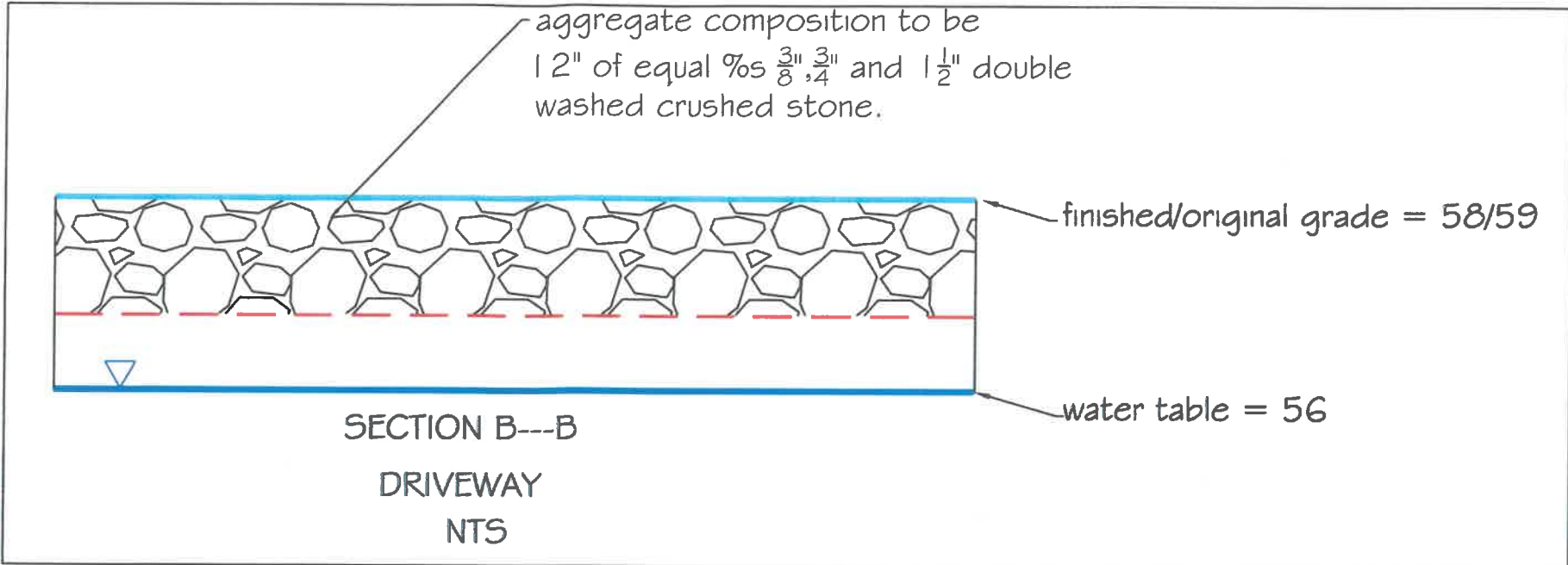

Andrew Blodeau, Esq.
1350 Division Rd # 102
West Warwick, RI

Plat/Lot: 5/164

REVISIONS

DEVELOPMENT PLAN/
DRAINAGE DETAILS -2
BEACH AVE PLAT 5 LOT 164
JAMESTOWN, RI

RP Engineeng, Inc.
121 Suffolk Drive
North Kingstown, RI 02852
885-7255 (1050 fax)

Scale - NTS
Sheet - 3

1/23/20

Parcel ID: 5-106
GESUALDI, PETER J
153 BEACH AVENUE
JAMESTOWN RI 02835

Parcel ID: 5-107
ASHTON TABATHA & MARK TE
181 BELLEVUE AVENUE UNIT 413
NEWPORT RI 02840

Parcel ID: 5-109
HAMILTON, ANDREW D
P.O. BOX 644
WEST KINGSTON RI 02892

Parcel ID: 5-110
HOWLAND, ALBERTA E
105 STEAMBOAT AVE
JAMESTOWN RI 02835

Parcel ID: 5-111
TOWN OF JAMESTOWN
93 NARRAGANSETT AVENUE
JAMESTOWN RI 02835

Parcel ID: 5-144
TOWN OF JAMESTOWN
93 NARRAGANSETT AVENUE
JAMESTOWN RI 02835

Parcel ID: 5-145
CONANICUT ISLAND LAND TRUST
P.O. BOX 106
JAMESTOWN RI 02835

Parcel ID: 5-146
TOWN OF JAMESTOWN
TAX SALE LOT
93 NARRAGANSETT AVENUE
JAMESTOWN RI 02835

Parcel ID: 5-147
BOCCAROSSA, MARIO N ET UX
HILDEGARD K
91 TWIN OAK LANE
WILTON CT 06897

Parcel ID: 5-148
ANGIONE, ANTHONY J ET UX JOANNE
(EST)
C/O VERONICA ANGIONE
116 DANBURY ROAD, UNIT 1207
WILTON CT 06897-4462

Parcel ID: 5-149
RAPOZA, STEVEN
66 RIPTIDE STREET
JAMESTOWN RI 02835

Parcel ID: 5-150
MICEK, JOSEPH J
C/O 45 CONCORD AVE
W WARWICK RI 02893

Parcel ID: 5-151
SCHAAL, WILLIAM C. JR.
147 BEACH AVENUE
JAMESTOWN RI 02835

Parcel ID: 5-153
CLARKE, ROBERT
80 RIPTIDE STREET
JAMESTOWN RI 02835

Parcel ID: 5-161
BRONOVITSKY, ALEK
77 RIPTIDE STREET
JAMESTOWN, RI 02835

Parcel ID: 5-164
CATANZARO, BARTHOLOMEW &
MARJORIE
3 WOODCREST DRIVE
JOHNSTON, RI 02919

Parcel ID: 5-167
RUGGIERI, DAVID & BARBARA A.
190 WEST ALLENTON ROAD
NORTH KINGSTOWN RI 02852

Parcel ID: 5-168
TOWN OF JAMESTOWN
93 NARRAGANSETT AVENUE
JAMESTOWN RI 02835

Parcel ID: 5-169
TOWN OF JAMESTOWN
93 NARRAGANSETT AVENUE
JAMESTOWN RI 02835

Parcel ID: 5-170
TOWN OF JAMESTOWN
93 NARRAGANSETT AVENUE
JAMESTOWN RI 02835

Parcel ID: 5-199
MARBLE, JAMES E & GERTRUDE
161 RODMAN LANE
NORTH KINGSTOWN RI 02852-7563

Parcel ID: 5-200
TOWN OF JAMESTOWN
93 NARRAGANSETT AVENUE
JAMESTOWN RI 02835

Parcel ID: 5-201
TOWN OF JAMESTOWN
93 NARRAGANSETT AVENUE
JAMESTOWN RI 02835

Parcel ID: 5-202
TOWN OF JAMESTOWN
93 NARRAGANSETT AVENUE
JAMESTOWN RI 02835

Parcel ID: 5-205
MORIARTY, MATTHEW J & LAUREN M
132 BEACH AVENUE
JAMESTOWN RI 02835

Parcel ID: 5-206
MACDONALD, DONALD H JR ET
MACDONALD, GAIL C
124 LEONARD ST
RAYNHAM MA 02767

Parcel ID: 5-207
BETTENCOURT, JEFFREY ET
GUADALUPE, MARITANA F. TRUSTEES
20 RAVENWOOD ROAD
WEST HARTFORD CT 06107

Parcel ID: 5-220
KELLY, JOHN T & KELLY RAMONA L
123 BEACH AVE
JAMESTOWN, RI 02835

Parcel ID: 5-221
RI TNPK & BRIDGE AUTHORITY
P.O. BOX 437
JAMESTOWN RI 02835

Parcel ID: 5-222
RI TNPK & BRIDGE AUTHORITY
P.O. BOX 437
JAMESTOWN RI 02835

Parcel ID: 5-224

**CURCI, DENNIS ANTHONY TRUSTEE
739 MIDDLEBRIDGE ROAD
SOUTH KINGSTOWN RI 02879-7150**

Parcel ID: 5-225

**CURCI, D A BUILDERS LLC
376 DRY BRIDGE RD., STE. C-2
NORTH KINGSTOWN RI 02852**

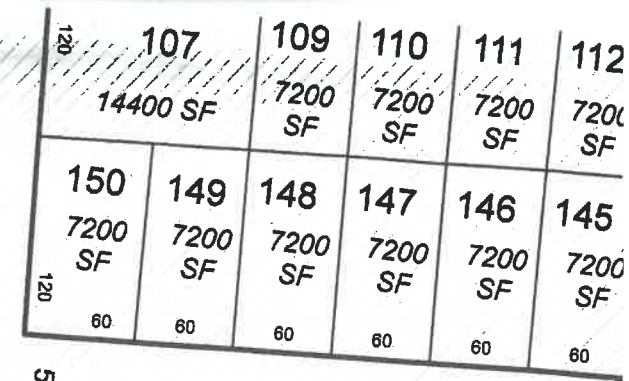
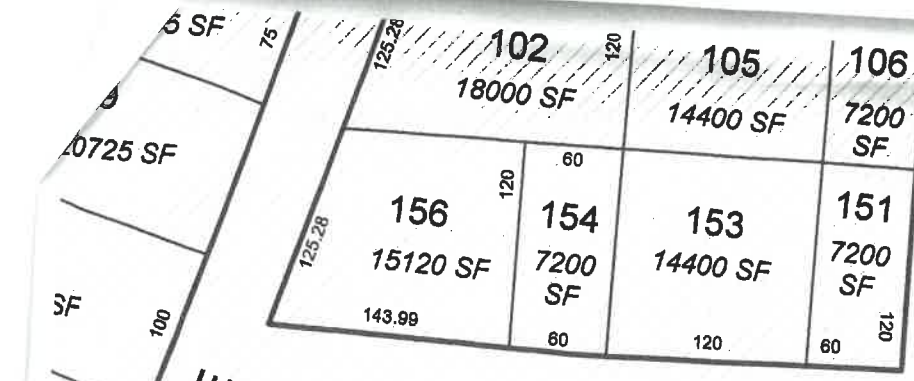

SEASIDE DRIVE

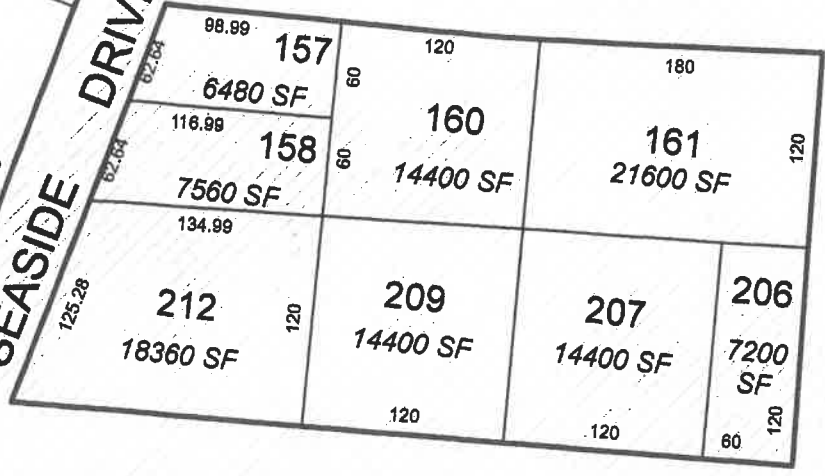

BEACH

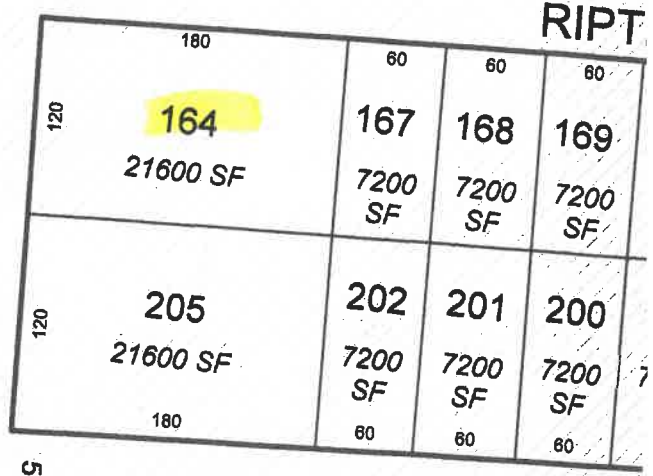

RIPT

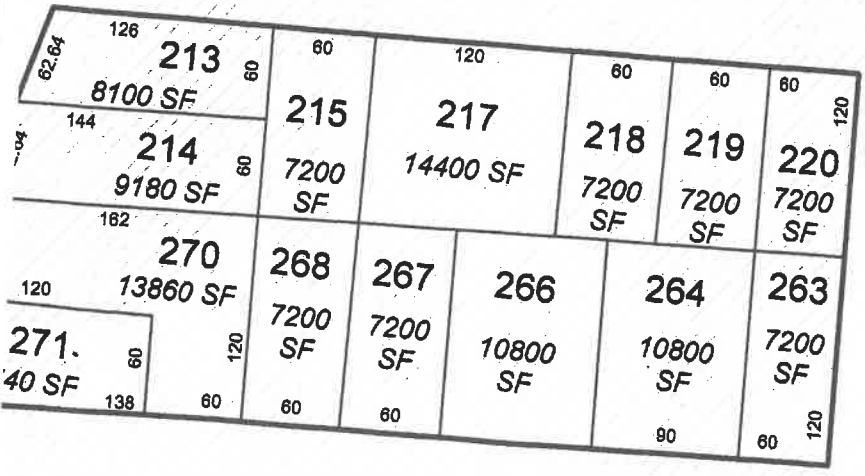

AVE

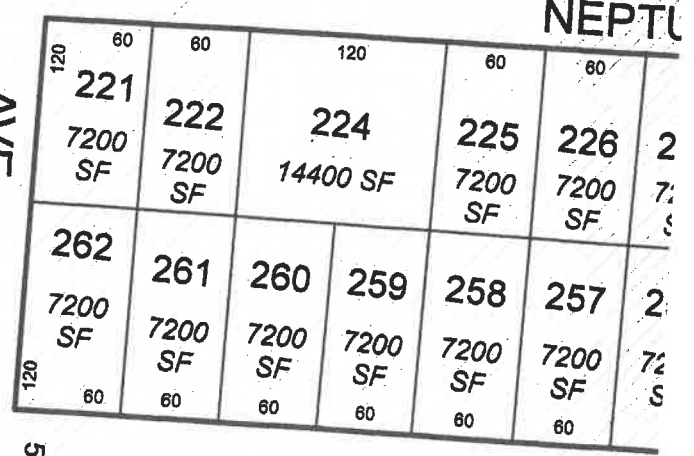

NEPTU

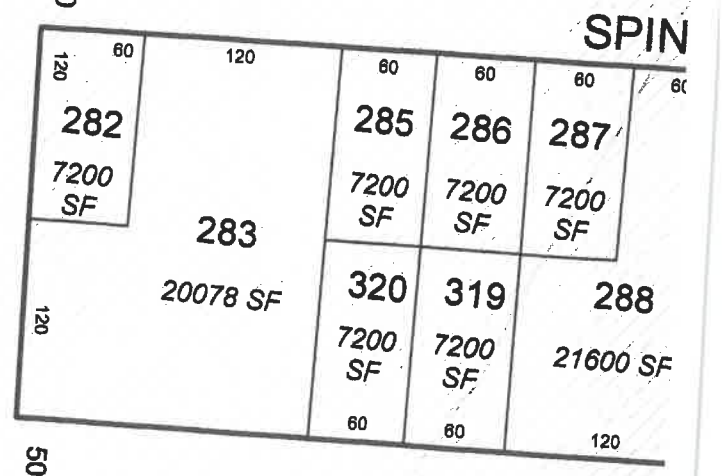
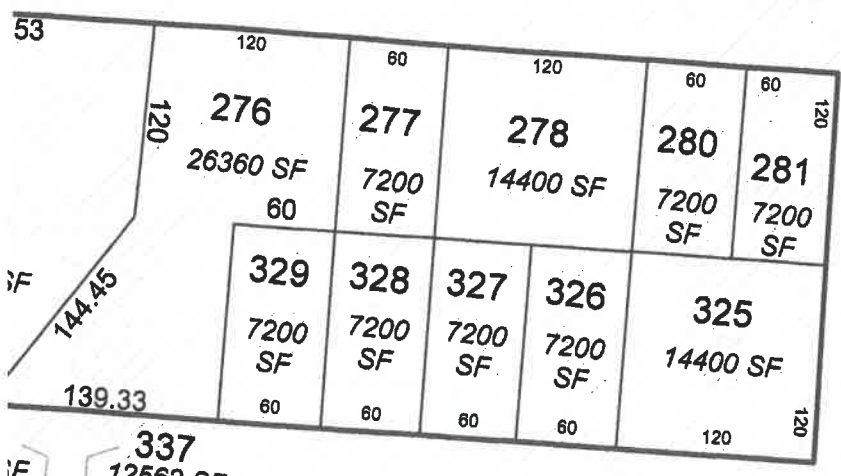

SPIN

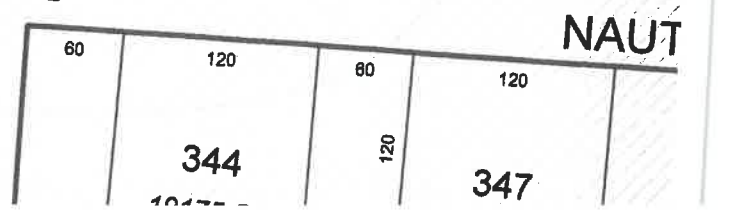
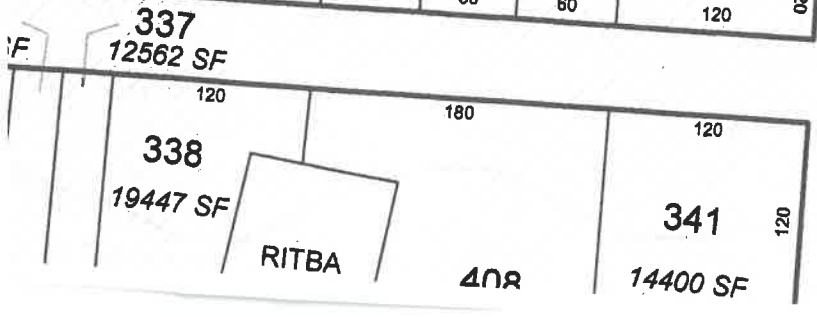

NAUT



Town of Jamestown

93 Narragansett Avenue
401-423-7200

Jamestown, Rhode Island
02835-1199

July 25, 2012

Mr. Bartholomew Catanzaro
3 Woodcrest Drive
Johnston, RI 02919

Dear Mr. Catanzaro,

The following is the decision on your Petition heard by the Town of Jamestown Zoning Board of Review on July 24, 2012.

After testimony was completed at the public hearing for which due notice was given and a record kept, the Town of Jamestown Zoning Board of Review, after taking into consideration all of the testimony and exhibits at the public hearing, makes the following determination:

A motion was made by Richard Allphin and seconded by David Nardolillo to grant the request of Bartholomew Catanzaro et ux Marjorie, whose property is located at Beach Ave., and further identified as Assessor's Plat 5, Lot 164 for a special use permit under Article 3, Section 82-314, Subdistrict "A" High Groundwater Table and Impervious Layer Overlay District, and a variance under Article 3, Section 3-2 (District Dimensional Regulations) to construct a 1,961 sq. ft. 3-bedroom dwelling and garage, which will be 30' from the front lot line, 40' required. Also a variance under Article 3, Section 82-308, Setback from Freshwater Wetland to install an Onsite Wastewater Treatment System 115' from the wetland instead of the required 150'.

Regarding this request, this Board has determined that this application does satisfy the requirements of ARTICLE 6, SECTION 600.

Regarding the request for a Variance, this Board has determined that this application does satisfy the requirements of ARTICLE 6, SECTION 606, PARAGRAPHS 1 through 4, and SECTION 607, PARAGRAPH 2.

Regarding the request for a Special Use Permit, this Board has determined that this application does satisfy the requirements of ARTICLE 6, SECTION 602.

This Variance is granted with the following restrictions:

1. This project must be constructed in strict accordance with the site and building plans duly approved by this Board.
2. Incorporate by reference the Planning Commission approval (Exhibit #3) of May 23, 2012.
3. A signed letter from Ms. Schultz (engineer) be filed as part of the conditions of the acceptance of this variance and shall be recorded with the deed.

This motion is based on the following findings of fact:

1. Said property is located in a R40 zone and contains 22,000 sq. ft.
2. Two neighbors stated concerns about the variances that have been granted in this "fragile" area.

The motion carried by a vote of 4 - 1.

David Nardolillo, Dean Wagner, Richard Cribb, and Richard Allphin voted in favor of the motion.

Thomas Ginnerty voted against the motion.

Judith Bell was not seated and Richard Boren and Joseph Logan were absent.

This special use permit and variance shall expire one year from the date of granting unless the applicant exercises the permission granted.

Very truly yours,

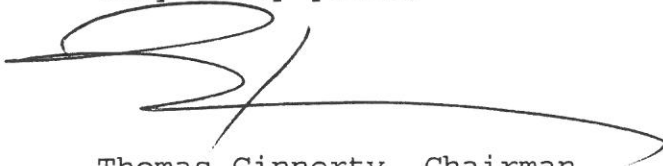

Thomas Ginnerty, Chairman
Jamestown Zoning Board of Review
TG/pw

RECEIVED FOR RECORD
Oct 24 2012 09:17:05A
JAMESTOWN TOWN CLERK
CHERYL A. FERNSTROM, CMC



Town of Jamestown, Rhode Island

93 Narragansett Ave
Jamestown, RI 02835 – 1509
Phone: (401) 423-7225
Fax: (401) 423-7229

To: Lisa Bryer
Town Planner

Fred Brown
Town Building Official

Cc: Bartholomew Catanzaro
3 Woodcrest Drive
Johnston RI 02919

From: Michael Gray, PE
Town Engineer

Justin Jobin
Environmental Scientist

Re: Bartholomew Catanzaro - Zoning Ordinance Section 314
High Groundwater Table and Impervious Overlay District
Sub-District A

Location: Plat 5 Lot 164, Beach Avenue

Date: May 22, 2012

Island Engineering has submitted a revised site plan that addresses the side setback concerns raised at the May 16th Planning Commission meeting. The proposed building footprint has been moved to the South to meet the required 30' side setback. This eliminated one of the dimensional variances the applicant is seeking. The applicant will still be seeking the following relief from the Zoning Board:

1. 35' of relief from Section 82-308(150' Freshwater Wetlands Setback)
2. Special Use Permit under Section 82-314 (Subdistrict "A" of HGWTO)
3. Dimensional Variance:

A front setback of 40' is required. The applicant is proposing a 30' setback due to the fact that RIDEM requires a 10' separation between the dwelling and perimeter wetland as part of their regulation, which prevents the applicant from moving the dwelling back 10' to meet the Town Zoning Requirements. A dimensional variance will be required.



Town of Jamestown, Rhode Island

93 Narragansett Ave
Jamestown, RI 02835 – 1509
Phone: (401) 423-7225
Fax: (401) 423-7229

To: Lisa Bryer
Town Planner

Cc: Bartholomew Catanzaro
3 Woodcrest Drive
Johnston RI 02919

From: Michael Gray, PE
Town Engineer

Justin Jobin
Environmental Scientist

Re: Bartholomew Catanzaro - Zoning Ordinance Section 314
High Groundwater Table and Impervious Overlay District
Sub-District A

Location: Plat 5 Lot 164, Beach Avenue

Date: May 11, 2012

We are in receipt of plans and drainage analysis prepared by Island Engineering as well as the OWTS Permit completed by Coventry Survey Inc. The applicant is proposing to construct a three-bedroom dwelling on the above referenced 22,000 SF vacant lot. The soil evaluation reports provided indicate that the depth to seasonal high groundwater is 24" and the depth to Category 9 soils is 31" placing this application in sub-district A.

The Applicant's OWTS permit from RIDEM shows the leachfield placed approximately 115 feet from the freshwater wetland edge, which requires a variance of 35' from Zoning Section 308. Section 82-308 of The Town of Jamestown's Code of Ordinance requires a 150 foot setback from the OWTS to freshwater wetlands. The Conservation Commission completed an advisory review of this application which is attached to this memo.

Fill and Grading

The applicant is not proposing the use of fill or significant grading changes on the lot.

Impervious Coverage

The Ordinance requires that the applicant exclude the area of wetlands on the lot when determining the amount of impervious coverage. After excluding the 6,038 SF of wetlands on the lot, the proposed impervious coverage of 13% still meets the requirements of the ordinance.

Onsite Wastewater System

The proposed Advantex onsite wastewater treatment system and bottomless sand filter leachfield provides advanced treatment, and meets the requirements of this ordinance.

Stormwater Controls

In order to mitigate the increase in runoff from the proposed improvements and disturbance to the wetlands, the applicant has proposed the use of an 8 inch deep, 316 SF Bioretention swale and pervious driveway. The proposed stormwater controls meet the requirement of the ordinance, and were required as part of the RIDEM Freshwater Wetlands Approval. However, it is important to note that the Town prefers the applicant to provide a minimum of 1 foot separation between the bottom of the stormwater control and the seasonal high groundwater table but in this case the applicant is only able to provide a 10" separation to the seasonal high groundwater table. In addition, we recommend that the construction, maintenance, and planting requirement of the bioretention area be recorded into land evidence with the Town Clerk.

Overview of Lot



Summary:

The applicant will be seeking the following from the Zoning Board:

1. 35' of relief from Section 82-308(150' Freshwater Wetlands Setback)
2. Special Use Permit under Section 82-314 (Subdistrict "A" of HGWTO)
3. Dimensional Variances
 - a. A front setback of 40' is required. The applicant is proposing a 30' setback due to the fact that RIDEM requires a 10' separation between the dwelling and perimeter wetland as part of their regulation, which prevents the applicant from moving the dwelling back 10' to meet the Town Zoning Requirements. A dimensional variance will be required.
 - b. A corner side setback of 30' is required. The applicant is proposing to construct a garage within this setback and a dimensional variance will be required.

We have provided a review of the site plan and drainage analysis for the above referenced lot. We believe that the application is complete and meets the requirements of the Zoning Section 314, The High Groundwater and Impervious Coverage Ordinance. We recommend that this application be placed on the agenda for the May 16th Planning Commission Meeting.

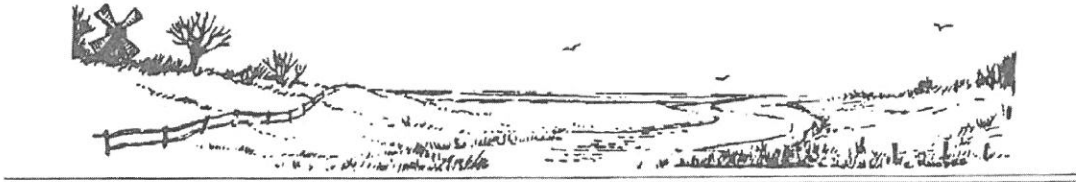

JAMESTOWN CONSERVATION COMMISSION

To: Planning Commission Members

From: Carol Lynn Trocki, Conservation Commission Chair

Carol Lynn Trocki

Date: April 16, 2012

Re: Conservation Commission Advisory Review of Sec. 82-308 Variance Request from Bartholomew & Marjorie Catanzaro, Plat 5 / Lots 164

At our meeting on April 10th, members of the Conservation Commission reviewed Mr. & Mrs. Catanzaro's development plans in response to their request for a variance from the 150 foot freshwater wetland setback required by Section 82-308 of the Town of Jamestown's Code of Ordinance. Given the Conservation Commission's charge, which includes the protection of the Town's water resources, we offer the following comments on the Catanzaro's variance request for your consideration:

1. The current development plan (prepared by Island Engineering, LLC. and dated 11/29/2011) shows an advanced technology onsite wastewater treatment system (OWTS) placed approximately 115 feet from the wetland edge, requiring a variance of 35 feet. It was the opinion of the Conservation Commission that a variance of this magnitude had limited potential to degrade the quality of groundwater and freshwater wetlands in the immediate vicinity, especially given the presence of a fully vegetated wooded buffer of greater than 50 feet between the wetland edge and the limit of disturbance and the proposed bioretention area.
2. Commissioners felt that the Catanzaro's have made a reasonable effort to limit the size of the building footprint and site the dwelling and wastewater treatment system so as to minimize wetland impacts. These efforts are enhanced by the preservation of a 50-foot wide fully vegetated wooded buffer.
3. Commissioners were convinced that the proposed development would not reduce the net capacity of the site to retain floodwaters given the proposed bioretention area and pervious driveway.
4. Appropriate erosion control measures, a pervious driveway, and a bioretention area have been proposed for the site. Commissioners felt that these efforts, along with the preservation of a 50-foot wide fully vegetated wooded buffer, reasonably limit the chances that sedimentation could negatively impact adjacent freshwater wetlands.

5. Commissioners felt that the proposed advanced technology OWTS, bioretention area and preservation of the wooded buffer adequately mitigate the chances that the capacity of the adjacent wetland to absorb pollutants would be reduced by this development.

6. After considering the extent of both existing residential development and freshwater wetlands within a 500' radius of the site, Commissioners concluded that design of this proposal (including the development sighting, use of erosion controls and pervious materials, and the proposed bioretention area) represents little or no addition to the cumulative impacts on nearby freshwater wetlands.

In light of these considerations, members of the Conservation Commission voted unanimously to recommend the approval of this variance request.

Cc: Lisa Bryer, Town Planner
Bartholomew & Marjorie Catanzaro



**Town of Jamestown Worksheet
Zoning Section 314
High Ground Water Table and
Impervious Layer Overlay District**

To Be Completed by the Engineer of Record:

SECTION I: PROPERTY INFORMATION

PROPERTY OWNER: BARTHOLOMEW CATANZARO
TELEPHONE: (401) 231-5276 OTHER NUMBER: FAX: 231-4631
MAILING ADDRESS: 3 WOODCREST DRIVE
JOHNSTON, RI 02917
SITE LOCATION: BEACH AVENUE (CORNER OF RIPTIDE) (STREET)
PLAT: 5 LOT: 164

SECTION II: SOILS INFORMATION

CLASS IV SOIL EVALUATOR: PETER D. SUORSA (DECEASED)
NAME: COVENTRY SURVEY CO., INC. TELEPHONE: (401) 823-5028
DEPTH TO SEASONAL HIGH GROUNDWATER TABLE IN INCHES: 24"
DEPTH TO CATEGORY 9 SOILS IN INCHES: #1-34", #2-32", #3-31", #4-38", #5-34"
TEST PIT # 1 EXISTING GRADE: 58' DEM GWT CONFIRMED @ 24", ELEVATION 56'
TEST PIT # 2 EXISTING GRADE: 58' DEM GWT CONFIRMED @ 24", ELEVATION 56'
TEST PIT # 3 EXISTING GRADE: 58' DEM GWT CONFIRMED @ 24", ELEVATION 56'
#4 58' 24" 56'
#5 58' 18"
USE ADDITIONAL SHEETS IF NECESSARY & ATTACH ALL SOIL EVALUATIONS

SECTION III: OWTS INFORMATION:

TYPE OF OWTS: BOTTOMLESS SAND FILTER W/ADVANTEK FILTER

FINAL EFFLUENT CONCENTRATIONS:

TOTAL NITROGEN (mg/L): 15 TSS (mg/L): 20 BOD 5(mg/L): 20

PATHOGEN FECAL COLIFORM REMOVAL: 97%

IF THE DISTANCE BETWEEN THE WELL AND LEACHFIELD IS LESS THAN 100 FT, WHAT IS THE FINAL CONCENTRATION OF FECAL COLIFORM PER 100 ml: N/A

IS THE OWTS LOCATED ON THE SAME LOT AS THE STRUCTURE IT SERVES? YES

OWTS DESIGN DEPTH TO SEASONAL HIGH GROUND WATER TABLE: 36"

GRADE IN AREA OF PROPOSED LEACHFIELD: 58 ' CURRENT 58 ' PROPOSED
SEASONAL HIGH GROUNDWATER ELEVATION IN THIS LOCATION: 56
ELEVATION OF LEACHFIELD INVERT AT BOTTOM OF STONE: TOP OF FILTER SAND 59'

SECTION IV: SITE INFORMATION

TYPE OF STORMWATER CONTROL SYSTEM: BIO-RETENTION POND / PERVIOUS DRIVE

ATTACH COPIES OF DRAINAGE CALCULATIONS

GRADE IN AREA OF PROPOSED STORMWATER CONTROL SYSTEM:

58 ' CURRENT 56.83 ' PROPOSED

SEASONAL HIGH GROUNDWATER ELEVATION IN THIS LOCATION: 56

SEPERATION DISTANCE BETWEEN BOTTOM OF STORMWATER CONTROL SYSTEM AND SEASONAL HIGH GROUNDWATER TABLE: 10" @ BIO-RETENTION POND & 1' @ DRIVE

TOTAL LOT AREA: 21,600 SF

TOTAL AREA OF WETLANDS ON LOT: 6,038 SF

TOTAL BUILDABLE AREA (TOTAL LOT AREA - WETLAND AREA): 15,562 SF

PERCENT IMPERVIOUS COVERAGE ALLOWED UNDER SECTION 314: 13%

PERCENT IMPERVIOUS COVERAGE PROPOSED (MUST USE TOTAL BUILDABLE AREA NOT TOTAL LOT AREA): 13%

SECTION V: ENGINEER (S) / DESIGNER (S) OF RECORD

OWTS
DESIGNER: COVENTRY SURVEY CO., INC.
JOHN ROCKWELL, PLS 1959 DATE: 4-30-12
John Rockwell

DESIGNER LICENSE #: D-2089

STORMWATER CONTROL SYSTEM ISLAND ENGINEERING, LLC
DESIGNER: _____ DATE: _____

DESIGNER LICENSE #: _____



January 13, 2012

Bartholomew Catanzaro
3 Woodcrest Drive
Johnston, RI 02917

Insignificant Alteration – Permit

Re: Application No. 11-0199 in reference to the property and proposed project located:

Approximately 30 feet east of Beach Avenue and approximately 30 feet south of its intersection with Riptide Street, Utility Pole No. 20, Assessor's Plat 5, Lot 164, Jamestown, RI

Dear Mr. Catanzaro:

Kindly be advised that the Department of Environmental Management's ("DEM") Freshwater Wetlands Program ("Program") has completed its review of your **Request for Preliminary Determination** application. This review included a site inspection of the above referenced property ("subject property") and an evaluation of the proposed three (3) bedroom single family dwelling with associated driveway, well, septic system, landscaping, and stormwater management plan as illustrated and detailed on site plans submitted with your application. These site plans were received on December 20, 2011.

Our observations of the subject property, review of the site plans and evaluation of the proposed project reveals that alterations of freshwater wetlands are proposed. However, pursuant to Rule 9.00 of the Rules and Regulations Governing the Administration and Enforcement of the Fresh Water Wetlands Act (Rules), this project may be permitted as an **insignificant alteration** to freshwater wetlands under the following terms and conditions:

Terms and Conditions for Application No. 11-0199:

1. This letter is the DEM's permit for this project under the R.I. Fresh Water Wetlands Act, Rhode Island General Laws (RIGL) Section 2-1-18 et seq.
2. This permit is specifically limited to the project, site alterations and limits of disturbance as detailed on the site plans submitted with your application and received by the DEM on December 20, 2011. A copy of the site plans stamped approved by the DEM is enclosed. Changes or revisions to the project, which would alter freshwater wetlands are not authorized without a permit from the DEM.
3. Where the terms and conditions of the permit conflict with the approved site plans, these terms and conditions shall be deemed to supersede the site plans.
4. You must notify this Program in writing immediately prior to the commencement of site alterations and upon completion of the project.

Application No. 11-0199

2

5. A copy of the stamped approved site plans and a copy of this permit must be kept at the site at all times during site preparation, construction, and final stabilization. Copies of this permit and the stamped approved plans must be made available for review by any DEM or City/Town representative upon request.
6. Within ten (10) days of the receipt of this permit, you must record this permit in the land evidence records of the Town of Jamestown and supply this Program with written documentation obtained from the Town showing this permit was recorded.
7. The effective date of this permit is the date this letter was issued. This permit expires on July 1, 2017 unless renewed pursuant to the Rules.
8. Any material utilized in this project must be clean and free of matter that could pollute any freshwater wetland.
9. Prior to commencement of site alterations, you shall erect or post a sign resistant to the weather and at least twelve (12) inches wide and eighteen (18) inches long, which boldly identifies the initials "DEM" and the application number of this permit. This sign must be maintained at the site in a conspicuous location until such time that the project is complete.
10. Temporary erosion and sediment controls detailed or described on the approved site plans shall be properly installed at the site prior to or commensurate with site alterations. Such controls shall be properly maintained, replaced, supplemented, or modified as necessary throughout the life of this project to minimize soil erosion and to prevent sediment from being deposited in any wetlands not subject to disturbance under this permit.
11. Also prior to commencement of any site alterations, permanent buffer zone markers must be installed along the limit of disturbance at the locations indicated in red ink on the approved site plans, in order to provide permanent reference points on site that are clear to present and future property owners. Acceptable permanent type markers include 4" x 4" pressure treated timber posts, galvanized fence posts with cap, or granite or concrete bounds. Markers must extend a minimum 24" above grade. A permanent-type tag or sign labeled "RIDEM Buffer Zone" must be placed on each marker. A permanent-type fence at least 24" tall placed along the limits of disturbance and similarly labeled may be substituted where desired. **No alterations of any kind are permitted beyond these markers without first obtaining the necessary permit from this Program.**
12. Immediately upon installation of the buffer zone markers, this Program must be contacted to arrange an on-site inspection. Once proper installation has been confirmed by this Program, work may be initiated on the project as herein approved.
13. Upon permanent stabilization of all disturbed soils, temporary erosion and/or sediment controls consisting of silt fence must be removed.
14. You are responsible for the proper installation, operation, maintenance and stability of any mitigative features, facilities, and systems of treatment and control which are installed or used in compliance with this permit to prevent harm to adjacent wetlands until such time that you document that this responsibility has been assumed by another person or organization.

Application No. 11-0199

3

15. You are obligated to install, utilize and follow all best management practices detailed or described on the approved site plans in the construction of the project to minimize or prevent adverse impacts to any adjacent freshwater wetlands and the functions and values provided by such wetlands.
16. All plantings of shrubs or other forms of vegetation as shown or detailed on the approved plans for the bio-retention must be installed as soon as possible after completion of final grading; weather and season permitting. Any plantings, which fail to survive one full growing season shall be replaced. Replacement plantings shall be similarly guaranteed for one full growing season.

Kindly be advised that a permit is needed from the O.W.T.S. Program prior to commencing any work on this project.

Pursuant to the provisions in Rule 7.09 and Rule 11.04, as applicable, any properly recorded and valid permit is automatically transferred to the new owner upon sale of the property

Kindly be advised that this permit is not equivalent to a determination of the type or extent of freshwater wetlands on the subject property. Should you wish to obtain such verification, you may submit an application in accordance with Rule 8.03.

You are required to comply with the terms and conditions of this permit and to carry out this project in compliance with the Rules at all times. Failure to do so may result in an enforcement action by this Department.

In permitting the proposed alterations, the DEM assumes no responsibility for damages resulting from faulty design or construction.

This permit does not remove your obligation to obtain any local, state, or federal approvals or permits required by ordinance or law and does not relieve you from any duties owed to adjacent landowners with specific reference to any changes in drainage.

Please contact Shawna B. Smith (telephone: 401-222-6820, ext. 7427) should you have any questions regarding this letter.

Sincerely,

Nancy L. Freeman

Nancy L. Freeman, Senior Environmental Scientist
Office of Water Resources
Freshwater Wetlands Program
NLF/SBS/sbs

RECEIVED FOR RECOR.
Jan 23, 2012 09:39:04A
JAMESTOWN TOWN CLERK
CHERYL A. FERNSTROM, LLC

Enclosure: Approved site plans

xc: Fred Brown, Jamestown Building Official
Brian Moore, Supervisor "OWTS" Program
Nikki Schultz, Island Engineering, LLC
Linda Steere, Applied Bio-Systems, Inc.
John Rockwell, Coventry Surveying Co., Inc.



STATE OF RHODE ISLAND AND PROVIDENCE PLANTATIONS
 Department of Environmental Management
 Office of Water Resources



Site Evaluation Form

Part A - Soil Profile Description

Application Number 9015-0061

Property Owner: BARTHOLOMEW CATANZARO RATS Lot 164

Property Location: OPPOSITE POLE #20 BEACH AVENUE JAMESTOWN

Date of Test Hole: MARCH 15, 2005

Soil Evaluator: PETER SUORSA

License Number: D4049

Weather: MOSTLY SUNNY 40°

Shaded: Yes No Time: 11:00 AM

Profile # / Horizon	Depth	Horizon Boundaries		Soil Colors		Re-Dox Description			Texture	Structure	Consistence	Soil Category
		Dist	Topo	Matrix	Re-Dox Features	Ab.	S.	Con.				
AP	0" - 7"	C	S	10YR 3/2	-	-	-	-	fsl	fine gran	fr.	3
Bw1	7" - 20"	g	S	2.5Y 4/3	-	-	-	-	fsl	fine 1-sbk	fr.	3
Bw2	20" - 34"	a	W	2.5Y 4/4	7.5YR 5/8	c	m	d	fsl	med. 1-sbk	fr.	3
2Cdg	34" - 78"	-	-	2.5Y 4/1	7.5YR 5/8	c	m	d	sil	o-m	fi.	9
Profile # / Horizon	Depth	Horizon Boundaries		Soil Colors		Re-Dox Description			Texture	Structure	Consistence	Soil Category
Profile # / Horizon	Depth	Dist	Topo	Matrix	Re-Dox Features	Ab.	S.	Con.				
AP	0" - 6"	g	S	10YR 3/2	-	-	-	-	fsl	fine gran.	fr.	3
Bw1	6" - 19"	c	W	2.5Y 4/3	-	-	-	-	fsl	fine 1-sbk	fr.	3
Bw2	19" - 32"	a	W	2.5Y 5/4	7.5YR 5/8	c	m	d	sl	fine 1-sbk	fr.	3
2Cdg	32" - 68"	-	-	2.5Y 4/1	-	-	-	-	sil	o-m	fi.	9

Soil Class: BASAL TILL / DENSE TILL
 Depth to Groundwater Seepage: #1 - 64" #2 - 62"
 Estimated Seasonal High Water Table: #1 - 24" #2 - 24"

Total Depth of each Test Hole: #1 - 78" #2 - 68"
 Depth to Impervious or Limiting Layer: #1 - NONE OBSERVED #2 - NONE OBSERVED
 Comments:



STATE OF RHODE ISLAND AND PROVIDENCE PLANTATIONS
 Department of Environmental Management
 Office of Water Resources



Site Evaluation Form

Part A - Soil Profile Description

Application Number 9015-0061

Property Owner: BARTHOLOMEW CATANZARO RAT5 LOT 164

Property Location: OPP. POLE #20 BEACH AVENUE JAMESTOWN

Date of Test Hole: MARCH 15, 2005

Soil Evaluator: PETER SUORSA License Number: D4049

Weather: Mostly Sunny 40° Shaded: Yes No Time: 11:00 AM

M # 3 Horizon	Depth	Horizon Boundaries		Soil Colors		Re-Dox Description			Texture	Structure	Consistence	Soil Category
		Dist	Topo	Matrix	Re-Dox Features	Ab.	S.	Con.				
AP	0"-6"	C	S	10YR 3/3	-	-	-	-	fsl	fine gran.	fr.	3
Bw1	6"-18"	g	S	2.5Y 4/2	-	-	-	-	fsl	fine l-sbk	fr.	3
Bw2	18"-31"	a	W	2.5Y 4/3	7.5YR 5/8	f	m	d	fsl	med. l-sbk	fr.	3
2Cdg	31"-64"	-	-	2.5Y 4/1	-	-	-	-	sil	0-M	fi.	9
M # 4 Horizon	Depth	Horizon Boundaries		Soil Colors		Re-Dox Description			Texture	Structure	Consistence	Soil Category
		Dist	Topo	Matrix	Re-Dox Features	Ab.	S.	Con.				
AP	0"-5"	C	S	10YR 3/3	-	-	-	-	fsl	fine gran.	fr.	3
Bw1	5"-13"	g	S	2.5Y 4/3	-	-	-	-	fsl	fine l-sbk	fr.	3
Bw2	13"-38"	a	W	2.5Y 5/4	7.5YR 5/8	f	m	d	sl	fine l-sbk	fr.	3
2Cdg	38"-72"	-	-	2.5Y 4/1	-	-	-	-	sil	0-M	fi.	9

Soil Class: DENSE TILL
 Depth to Groundwater Seepage: #3-60" #4-47"
 Estimated Seasonal High Water Table: #3-24" #4-24"

Total Depth of each Test Hole: #3-78" #4-105"
 Depth to Impervious or Limiting Layer: #3-78" #4-90"
 Comments: _____

