



TOWN COUNCIL MEETING
Jamestown Town Hall
Rosamond A. Tefft Council Chambers
93 Narragansett Avenue
Monday, January 7, 2019
6:30 PM

The public is welcome to participate in this Town Council meeting. Open Forum offers citizens the opportunity to clarify an item on the agenda, address items not on the agenda, or comment on a communication or Consent Agenda item. Citizens are welcome to speak to the subject of a Public Hearing, and are allowed to speak at the discretion of the Council President or a majority of Councilors present, or at other times during the meeting, in particular during New or Unfinished Business.

Anyone wishing to speak should use the microphone at the front of the room, stating their name and address for the record; comments must be addressed to the Council, not the audience. It is the Town Council's hope that citizens and Councilors alike will be respectful of each other's right to speak, tolerant of different points of view, and mindful of everyone's time.

Attachments for items on this meeting agenda are available to the public on the Town website at: <http://www.jamestownri.gov/town-government/town-council/town-council-meetings-minutes/2018-meetings-minutes/2018-meetings>

I. ROLL CALL

II. CALL TO ORDER, PLEDGE OF ALLEGIANCE

III. TOWN COUNCIL SITTING AS THE BOARD OF WATER AND SEWER COMMISSIONERS

IV. ACKNOWLEDGEMENTS, ANNOUNCEMENTS, PRESENTATIONS, RESOLUTIONS AND PROCLAMATIONS

V. PUBLIC HEARINGS, LICENSES AND PERMITS

All approvals for licenses and permits are subject to the resolution of debts, taxes and appropriate signatures as well as, when applicable, proof of insurance.

A) Town Council Sitting as the Alcoholic Beverage Licensing Board

- 1) REQUEST** that the application listed below will be in order for hearing at a meeting of said Licensing Board on Monday, February 4, 2019 at 6:30 p.m. and advertised in the *Jamestown Press*. **NOTICE:** Is hereby given by the Town Council of the Town of Jamestown, being the Licensing Board in said Town as provided under Title 3, Chapters 1-12 of the General Laws of Rhode Island 1956, and as amended, that the following **TRANSFER** application has been received by the Town Council under said Act, for the period February 4, 2019 to November 30, 2019; review, discussion and/or potential action and/or vote:

TRANSFER OF CORPORATE STOCK:

CLASS B – VICTUALER

ESJ, Inc.
dba: Simpatico Jamestown
13 Narragansett Avenue
Benjamin L. Brayton 100%

NEW CORPORATE STOCK HOLDERS:

CLASS B - VICTUALER

ESJ, Inc.
dba: Simpatico Jamestown
13 Narragansett Avenue
Benjamin L. Brayton 50%
Amy Barclay de Tolly 50%

- 2) **REQUEST** that the application listed below will be in order for hearing at a meeting of said Licensing Board on Monday, February 4, 2019 at 6:30 p.m. and advertised in the *Jamestown Press*. **NOTICE:** Is hereby given by the Town Council of the Town of Jamestown, being the Licensing Board in said Town as provided under Title 3, Chapters 1-12 of the General Laws of Rhode Island 1956, and as amended, that the following **NEW** application has been received by the Town Council under said Act, for the period February 4, 2019 to November 30, 2019; review, discussion and/or potential action and/or vote:

NEW LICENSE:

CLASS B – VICTUALER – LIMITED

Johnny Angels Clam Shack LLC
dba: Angel’s Kitchen
23 Narragansett Avenue
Jamestown, RI 02835

VI. OPEN FORUM

Please note that, under scheduled requests to address, if the topic of the address is available to be put on the agenda, the Council may discuss the issue

- A) Scheduled request to address
- B) Non-scheduled request to address

**VII. COUNCIL, ADMINISTRATOR, SOLICITOR,
COMMISSION/COMMITTEE COMMENTS & REPORTS**

VIII. UNFINISHED BUSINESS

For past discussion documentation, please visit <http://www.jamestownri.gov/town-government/town-council/town-council-meetings-minutes/2018-meetings-minutes/2018-meetings>

- A) Appointment of Town Solicitor and Prosecutor; review, discussion and/or potential action and/or vote
 - 1) Letters of interest and resumes
 - a) Archer & Foppert; interview conducted
 - b) Ruggiero, Brochu & Petrarca; interview conducted
- B) Appointment of Probate Judge; review, discussion and/or potential action and/or vote
 - 1) Letters of interest and resumes
 - a) Peter M. Cosel
 - b) Richard P. D'Addario
 - c) Stephen M. Miller
 - d) James P. Howe
 - e) Anthony F. Amalfetano
 - f) Gregory F. Fater
 - g) Mark E. Liberati
 - h) Jeffrey M. Liptrot
 - i) Richard A. Boren
 - j) Stephen P. Levesque
 - k) Matthew M. Mannix
 - l) Christine W. Ariel
- C) Upcoming Meetings and Sessions – dates and times
 - 1) Town Council Meeting Schedule – January 22nd, February 4th, and February 19th at 6:30 p.m.; review, discussion and/or potential action and/or vote
 - 2) Council Tour of Town Facilities, Interview sessions for Probate Judge and Board/Commission/Committee vacancies; review, discussion and/or potential action and/or vote

IX. NEW BUSINESS

- A) Jamestown Tree Warden, pursuant to RIGL §2-14-2; annual appointment; review, discussion and/or potential action and/or vote
 - 1) Letter of interest for reappointment
 - a) Steve Saracino
 - 2) Letter of recommendation for reappointment
 - a) Jamestown Tree Preservation and Protection Committee
- B) Town Council Liaison Positions; review, discussion and/or potential action and/or vote
 - 1) School Committee
 - 2) Library Board of Trustees
 - 3) Conservation Commission
 - 4) Harbor Commission
 - 5) Tree Preservation and Protection Committee
 - 6) Senior Services
 - 7) Chamber of Commerce/Business Community
 - 8) Gould Island Restoration Advisory Board

- 9) Planning Commission/Affordable Housing Committee
- 10) Zoning Board of Review
- C) Parking at Mackerel Cove; review, discussion and/or potential action and/or vote

X. ORDINANCES, APPOINTMENTS, VACANCIES AND EXPIRING TERMS

- A) Appointments, Vacancies, and Expiring Terms; review, discussion and/or potential action and/or vote on each listed appointment and/or vacancy
 - 1) Jamestown Affordable Housing Committee (Two vacancies with One vacancy with a three-year term ending date of May 31, 2021, One vacancy with an unexpired three-year term ending date of May 31, 2020 and One vacancy with an unexpired three-year term ending date of May 31, 2019); duly advertised
 - a) Letter of interest for appointment
 - i) Sydney Keen
 - 2) Jamestown Conservation Commission (Two vacancies with three-year term ending dates of December 31, 2021); duly advertised
 - a) Letter of resignation
 - i) Bill Reardon
 - b) Letter of interest for reappointment
 - i) Phil Larson
 - c) Letters of interest for appointment
 - i) Jessica Wurzbacher
 - ii) Sydney Keen
 - iii) Susan Gorelick
 - 3) Jamestown Fire Department Compensation Committee (One vacancy with a three-year term ending date of May 31, 2021); duly advertised
 - a) Letter of resignation
 - i) Jerome Scott
 - b) Letter of interest for appointment
 - i) Sydney Keen
 - 4) Jamestown Harbor Management Commission (Three vacancies with three-year term ending dates of December 31, 2021); duly advertised
 - a) Letters of interest for reappointment
 - i) Eric Lexow
 - ii) Wayne Banks
 - iii) Daniel Wurzbacher
 - b) Letters of interest for appointment
 - i) John Primiano
 - ii) Nicholas Radesca
 - iii) Stephen Murphy
 - 5) Jamestown Juvenile Hearing Board (Two Alternate Member vacancies with two-year term ending dates of December 31, 2020); duly advertised

- a) Letter of resignation
 - i) Cheryl Petrosinelli
- b) Letter of interest for appointment
 - i) Sydney Keen
- 6) Jamestown Philomenian Library Board of Trustees (One vacancy with a three-year term ending date of December 31, 2021); duly advertised (no applicants)
 - a) Letters of resignation
 - i) Marianne Kirby
 - ii) Mary Lou Sanborn
- 7) Jamestown Planning Commission (One vacancy with a four-year term ending date of December 31, 2022); duly advertised
 - a) Letter of interest for reappointment
 - i) Dana Prestigiacomio
 - b) Letters of interest for appointment
 - i) Richard Lynn
 - ii) Sydney Keen
 - iii) Eric Brine
- 8) Jamestown Tree Preservation and Protection Committee (Three vacancies with One unexpired three-year term ending date of December 31, 2019 and Two three-year term ending dates of December 31, 2021); duly advertised (no applicants)
 - a) Letter of resignation (unexpired term)
 - i) Richard Lynn
 - b) Letters of resignation (full terms)
 - i) Peter Kallman
 - ii) Mark Girard
- 9) Jamestown Zoning Board of Review – Member (One vacancy with a five-year term ending date of December 31, 2023); duly advertised
 - a) Term limit reached
 - i) Richard A. Boren
 - b) Letter of interest for reappointment (per Charter Section 1002 Subsection (3))
 - i) Richard A. Boren
 - c) Letter of interest for reappointment and to serve as full Member from Alternate Member
 - i) Lisa Hough – 2nd Alternate
- 10) Jamestown Zoning Board of Review – Alternate Member (Three vacancies with one-year term ending dates of December 31, 2019); duly advertised
 - a) Letter of interest to remain as Alternate Member
 - i) Judy Bell – 1st Alternate
 - b) Letter of interest for appointment
 - i) Erik Brine

XI. CONSENT AGENDA

An item on the Consent Agenda need not be removed for simple clarification or correction of typographical errors. Approval of the Consent Agenda shall be equivalent to approval of each item as if it had been acted upon separately.

- A) Adoption of Town Council Minutes
 - 1) December 3, 2018 (regular meeting)
 - 2) December 13, 2018 (public hearing)
 - 3) December 17, 2018 (work session)
 - 4) December 17, 2018 (regular meeting)
 - 5) December 17, 2018 (executive session)
- B) Minutes of Town Boards/Commissions/Committees
 - 1) Jamestown Library Board of Trustees Building Committee (11/8/2018)
 - 2) Jamestown Library Board of Trustees (11/13/2018)
 - 3) Jamestown Traffic Committee (11/15/2018)
 - 4) Jamestown Zoning Board of Review (11/27/2018)
- C) CRMC Notices
 - 1) January 2019 Calendar
 - 2) Notice of application for Assent by Anthony J. Abbiati and Alicia J. Collins to construct a residential boating facility at Plat 2 Lot 95 East Passage of Narragansett Bay
 - 3) Notice of application for Assent by William C. and Virginia Prichett to construct a residential boating facility at Plat 2 Lot 82 East Passage of Narragansett Bay

XII. COMMUNICATIONS, PETITIONS, AND PROCLAMATIONS AND RESOLUTIONS FROM OTHER RHODE ISLAND CITIES AND TOWNS

- A) Communications
 - 1) Letter of CRMC and Save the Bay re: ensuring Rights-of-Way are maintained and available for public use
 - 2) Letter of Constance P. Rainone requesting reduction of interest charged for late payment of taxes
 - 3) RI League of Cities and Towns brochure for 2019 Annual Convention on Thursday, January 24, 2018 from 8:30 a.m. to 4:00 p.m., The Crowne Plaza Hotel, 801 Greenwich Avenue, Warwick, RI

XIII. AGENDA ITEMS FOR THE NEXT MEETING AND FUTURE MEETINGS

- A) Town Council Rules and Procedures (January 22)
- B) Town Council Goals and Objectives (January 22)
- C) Veterans' Exemptions (January 22)
- D) Proposed Department of Seniors (January 22)
- E) Water Resources Protection Committee (January/February)
- F) Conanicut Island Sanctuary Trail improvements (February)
- G) Authorization to proceed to 100% design and bid document development for Golf Course Clubhouse project (January/February)

- H) Budget Work Sessions for FY 2019-2020 (March)
- I) Future Improvements to East Ferry boat ramp
- J) Paper streets in Jamestown and water access
- K) Fire Alarm Box Replacement Program (January 22)

XIV. EXECUTIVE SESSION

XV. ADJOURNMENT

Pursuant to RIGL § 42-46-6(c) Notice of this meeting shall be posted on the Secretary of State's website and at the Town Hall and the Jamestown Philomenian Library. In addition, notice also may be posted at the Jamestown Police Station and on the Internet at www.jamestownri.gov.

ALL NOTE: This meeting location is accessible to the physically challenged. If communications assistance is needed or other accommodations to ensure equal participation, please call 1-800-745-5555, or contact the Town Clerk at 401-423-9800, via facsimile to 401-423-7230, or email to cfernstrom@jamestownri.net not less than three (3) business days prior to the meeting.

Posted on the RI Secretary of State website January 3, 2019

Please run the following ad in the *Jamestown Press* editions of January 10 and 17, 2019:



Jamestown, Rhode Island
NOTICE

It is hereby given by the Town Council of the Town of Jamestown, being the Licensing Board in said Town as provided under Title 3, Chapters 1-12 of the General Laws of the Town Council for the license **TRANSFER** under said Act:

TRANSFER OF CORPORATE STOCK:

CLASS B – VICTUALER

ESJ, Inc.

dba: Simpatico Jamestown
13 Narragansett Avenue
Benjamin L. Brayton 100%

NEW CORPORATE STOCK HOLDERS:

CLASS B - VICTUALER

ESJ, Inc.

dba: Simpatico Jamestown
13 Narragansett Avenue
Benjamin L. Brayton 50%
Amy Barclay de Tolly 50%

The above application will be in order for hearing at a meeting of said Licensing Board on **Monday, February 4, 2019 at 6:30 p.m.** at the Jamestown Town Hall, Rosamond A Tefft Council Chambers, 93 Narragansett Avenue, in said Jamestown, at which time and place all remonstrants may make their objections against granting this license.

By Order of the Town Council
Cheryl A. Fernstrom, CMC, Town Clerk

This meeting location is accessible to the physically challenged. If communications assistance is needed or other accommodations to ensure equal participation, please call 1-800-745-5555, or contact the Town Clerk at 401-423-9800, via facsimile to 401-423-7230, or email to cfernstrom@jamestownri.net not less than three (3) business days prior to the meeting.

Please run the following ad in the *Jamestown Press* editions of January 10 and 17, 2019



Jamestown, Rhode Island
NOTICE

It is hereby given by the Town Council of the Town of Jamestown, being the Licensing Board in said Town as provided under Title 3, Chapters 1-12 of the General Laws of Rhode Island 1956, and as amended, that the following application has been received by the Town Council for the **NEW** license under said Act, for the period February 5, 2019 to November 30, 2019.

NEW LICENSE:

CLASS B VICTUALER – LIMITED LIQUOR LICENSE

Johnny Angels Clam Shack LLC
dba: Angel's Kitchen
23 Narragansett Avenue
Jamestown, RI 02835

The above application will be in order for hearing at a meeting of said Licensing Board on **Monday, February 4, 2019 at 6:30 p.m.** at the Jamestown Town Hall, Rosamond A Tefft Council Chambers, 93 Narragansett Avenue, in said Jamestown, at which time and place all remonstrants may make their objections against granting this license.

By Order of the Town Council
Cheryl A. Fernstrom, CMC, Town Clerk

This meeting location is accessible to the physically challenged. If communications assistance is needed or other accommodations to ensure equal participation, please call 1-800-745-5555, or contact the Town Clerk at 401-423-9800, via facsimile to 401-423-7230, or email to cfernstrom@jamestownri.net not less than three (3) business days prior to the meeting.

**TOWN OF JAMESTOWN
NOTICE OF VACANCY
PROBATE JUDGE**

The Town of Jamestown seeks a qualified attorney to serve in the capacity of Probate Judge for the two year period 2018-2020. The Probate Judge must be admitted to practice as an attorney before the Rhode Island Supreme Court and engaged in the active practice of law in this State pursuant to Rhode Island General Law § 8-9-2.1 and Section 1302 of the Jamestown Town Charter. A letter of interest and resume should be submitted to Town Administrator Andrew E. Nota, Town of Jamestown, 93 Narragansett Avenue, Jamestown, RI 02835-1199 on or before Thursday, December 20, 2018. For more information contact the Town Administrator at 401-423-9805.

**TOWN OF JAMESTOWN
PROBATE JUDGE
APPLICANTS**

1. Peter M. Cosel*
2. Richard P. D'Addario
3. Stephen M. Miller
4. James P. Howe
5. Anthony F. Amalefetano
6. Gregory F. Fater
7. Mark E. Liberati*
8. Jeffrey M. Liptrot
9. Richard A. Boren*
10. Stephen P. Levesque*
11. Matthew M. Mannix
12. Christine W. Ariel*

*Jamestown residents

TITLE 2

Agriculture and Forestry

CHAPTER 2-14

Tree Wardens

SECTION 2-14-2

§ 2-14-2. Appointment by town council or city mayor.

Every town council at its regular meeting in January of each year, and the mayor of every city on or before February 1 each year, shall appoint a tree warden who is, or who within six (6) months of his or her assuming office, becomes an arborist, licensed under chapter 19 of this title, to engage in the business or practice of all phases of tree care, including, but without limiting the generality to the planting, pruning, trimming, spraying, or repairing of fruit, shade, forest and ornamental trees and shrubs.

History of Section.

(P.L. 1931, ch. 1763, § 1; G.L. 1938, ch. 225, § 1; impl. am. P.L. 1952, ch. 2973, § 4; G.L. 1956, § 2-14-2; P.L. 1962, ch. 150, § 1; P.L. 1966, ch. 173, § 1; P.L. 1994, ch. 149, § 1; P.L. 1999, ch. 259, § 1; P.L. 1999, ch. 317, § 1; P.L. 2000, ch. 78, § 1; P.L. 2000, ch. 450, § 1.)

December 18, 2018

Andrew Nota
Town Administrator
93 Narragansett Avenue
Jamestown RI, 02835

RE: TREE WARDEN REAPPOINTMENT

Dear Mr. Notta,

At this time, I would like to respectfully request to be reappointed as Tree Warden for the Town of Jamestown, Rhode Island. I have enjoyed my tenure in the position and look forward to having the opportunity to continue. As Tree Warden, and with assistance from the Tree Preservation and Protection Committee, and Jamestown's Department of Public Works we have consistently identified and completed important projects that have benefited the Town of Jamestown and its residents. We have also been successful in receiving grant assistance that have funded all of our identified projects to date and continue to be recognized as a Tree City USA Community.

Noteworthy projects:

- 1) The planning, coordination, and implementation of a tree and shrub planting project at Fort Getty.
- 2) The planning, design, and implementation of a sustainable Town Tree Nursery that included a solar powered irrigation system, deer fencing, storage shed, and miscellaneous tools and supplies.

Upcoming identified projects include continued Town-wide tree planting projects, Tree Management Educational seminars/lectures.

In closing, I would welcome the opportunity to be re-appointed as Jamestown's Tree Warden and to continue to meet the Town of Jamestown and its resident's high expectations.

Sincerely,

Steven Saracino
Tree Warden
Jamestown, RI 02835

Jamestown Tree Protection and Preservation Committee

Jamestown Town Council
Cheryl Fernstrom, Town Clerk
Jamestown, RI 02835

December 17, 2018

Dear Members of the Jamestown Town Council:

At the Jamestown Tree Protection and Preservation Committee's meeting on December 4, 2018, the committee recommended reappointment of Steven Saracino as Tree Warden for the Town of Jamestown for 2019.

During 2018, Mr. Saracino has been actively engaged in town and tree committee projects and educational programs. His 2018 accomplishments include, but are not limited to:

- Continued commitment to a resident donor regarding visual enhancement of the median on Fort Getty road via key tree plantings.
- Sourcing of trees for the median on Fort Getty Road and the transfer station. Several native trees have been planted at one side of the entrance to the transfer station.
- Collaboration with Michael Gray, director of the DPW, and DPW members regarding the Arbor Day educational celebration.
- Follow-up with Jamestown residents regarding applications for work on town trees.
- Working with residents to obtain appropriate trees for their landscapes from our tree nursery.
- Maintaining the health, inventory and security of our town tree nursery, including deer fencing.

On behalf of the Tree Committee, I commend Mr. Saracino for providing his expertise and input on committee work. The Tree Committee feels his continuation as Tree Warden is valuable to the Tree Committee and the town.

Sincerely,

Elaine Peterson

Elaine Peterson
Chairperson



TOWN OF JAMESTOWN
Parks & Recreation Office
P.O. Box 377
41 Conanicus Ave.
JAMESTOWN, RHODE ISLAND 02835

Recreation Office (401) 423-7260
Teen Center (401) 423-7261
Fort Getty (401) 423-7211
Fax (401) 423-7229

TO: Andrew E. Nota, Town Administrator
CC: Edward Mello, Chief of Police
FROM: Andrew J. Wade, Parks & Recreation Director
SUBJECT: Mackerel Cove – Parking Ordinance Recommendations
DATE: January 3, 2019

Over the past few summers, I have received concerns from residents regarding the high volume of non-resident parking at Mackerel Cove Beach during the summer months. It is the opinion of some residents that they should not be displaced by a non-resident when attempting to visit the Town's only staffed beach. Being a community that sees a significant influx of visitors and tourists between the end of June and September, I believe that if any changes are made to the current policies managing the beach, it is important to implement a balanced approach to protect both the resident and visitors that provide a needed boost to the local economy.

Existing Challenges:

Mackerel Cove Beach has limited parking. The perpendicular parking area at Mackerel Cove Beach is approximately 730 feet in length, which currently provides the public roughly 75-80 pull-in parking spots in front of the beach. Currently, during the summer when the beach is staffed by life guards and parking attendants, visitors to the beach are required to display parking passes. These passes come in two different forms:

1. *Resident Recreation Passes* – available to year round residents & property owners for \$15.00 per vehicle registered in their name. Stickers displayed on lower left driver side of windshield.
 - o Annually, approximately 2,000 stickers are sold to residents for use at Mackerel Cove and other areas that have been marked for "Resident Recreation Passes Required".
 - o Annual revenue from the sales average \$30,000.00.
2. *Non-Resident Day Passes* – sold to beach patrons by attendants. Placards are distributed to be displayed in the front windshield.
 - o Annually, depending on the weather, approximately 1,300 "Day Passes" are sold.
 - o Revenue from these sales delivers approximately \$20,000.00 in revenue.

Additional parking areas intended for use by residents surrounding Mackerel Cove.

- Parallel Parking West of the Beach – roughly 20 parallel spots exist on the south side of Beavertail Road between the beach and Fort Getty Road. These spots dedicated for "Resident Recreation Pass" to be displayed.
- Parallel Parking along the western most end of Hamilton Avenue. Approximately 23 spots are dedicated to Resident Recreation Pass holders.

Additional areas impacted by beach patrons.

- Parallel parking above Fox Run on Hamilton Avenue – On the busiest of days, parking extends up Hamilton past the “Resident Pass” spots.
- Fort Getty Road – Over the past few seasons, increased use of the Beavertail end of Fort Getty Rd. has been used by beach goers. This parking is often done on private property, as the town only owns the road proper, not any of the land off the pavement.

Potential Options:

In response to these recently expressed concerns regarding the limited availability of parking spaces at Mackerel Cove Beach for residents during the summer months I am recommending the following potential options to address the management of assigned parking areas during summer beach operation.

1. Visitor Rate Increased

- a. Daily Parking Pass Fee increased. \$30.00 per car
- b. Increased Fee will decrease users, compensate for potential revenue loss through increased fee.
- c. Will require substantial increase to parking violation fee. Currently patrons are willing to risk a parking ticket in Resident Only areas, and would do the same in Beach Parking if fines are not raised to be substantially greater than the parking cost.
- d. Displaced visitors will increase impact in surrounding areas such as Fort Getty Road and Hamilton Avenue.

2. Resident Only Parking – Non Residents Prohibited

- a. Parking restricted to Resident Recreation Pass Holders only.
- b. Non-Resident parking will be displaced to surrounding roads; additional action may be required related to traffic ordinances, fine increase.
- c. Non-Residents will continue to “risk” a ticket in Mackerel Cove Lot

3. Resident Only / Non-Resident Hybrid

- a. Reduce the amount of parking area dedicated to Non-Resident Daily Passes to the eastern most 25 spots on Weekends and Federal/State Holidays while beach is staffed through Labor Day. (as seen on attached diagram)
- b. The remaining perpendicular spots to the west (approx.. 50) will be dedicated for Resident Recreation Pass holders only on Weekends and Federal/State Holidays while beach is staffed through Labor Day. (as seen on attached diagram)
- c. During all other days of the week during the beach’s operation, parking will be managed as it was last summer. All spots require Resident Recreation Passes or Non-Resident Day Passes.
- d. Existing Handicapped Spots will remain first come first serve to those patrons with valid handicap placards for their vehicles.
- e. Non-Resident parking will be displaced to surrounding roads; additional action may be required related to traffic ordinances, fine increase.
- f. Non-Residents will continue to “risk” a ticket in Mackerel Cove Lot

Proposed Mackerel Cove 2019 Parking Plan

MONDAY—THURSDAYS *(Non Holidays)*

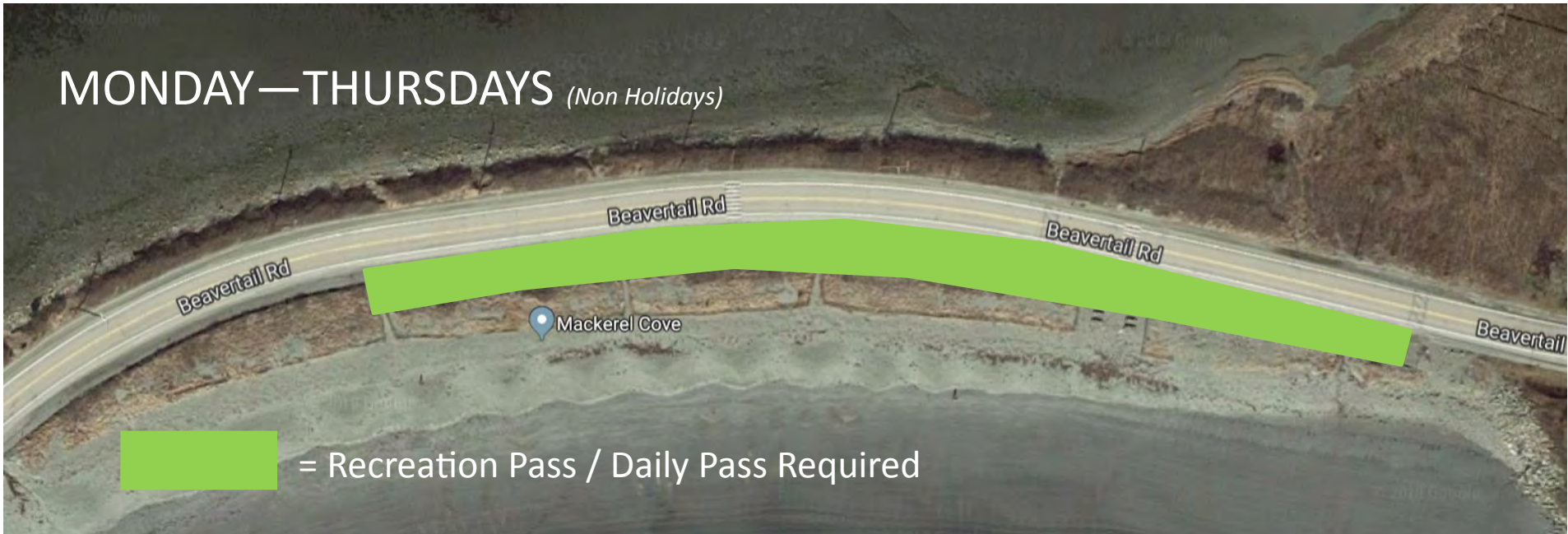

FRIDAY—SUNDAYS & HOLIDAYS

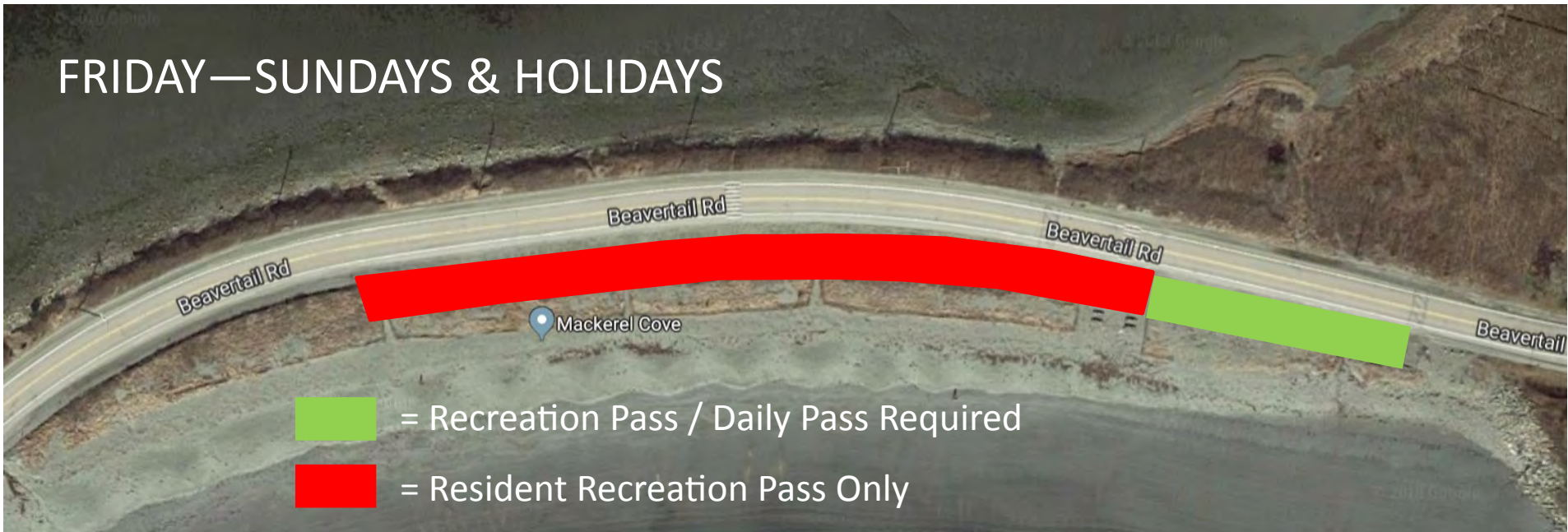

JAMESTOWN TOWN CHARTER

ARTICLE X. - BOARDS, COMMISSIONS AND COMMITTEES

Sec. 1002. - Membership and terms.

- (3) Unless otherwise mandated by state law or regulations, all terms of board, commission and committee membership shall be limited to three years. With the exception of the zoning board of review alternate members, no person shall serve more than three consecutive terms on the same committee and that person shall not be reappointed to that body for one year thereafter, unless the person has special qualifications required by the board, or for other good reason, with a unanimous vote of the council concurring with the reappointment.

(Amendment of 11-08-2016)

**TOWN COUNCIL MEETING
December 3, 2018**

I. ROLL CALL

Town Council Members present:

Michael G. White, President
Mary E. Meagher, Vice President
Nancy A. Beye
Randall White
William J. Piva, Jr.

Also in attendance:

Andrew E. Nota, Town Administrator
Christina D. Collins, Finance Director
Michael C. Gray, Public Works Director
Edward A. Mello, Police Chief
Lisa W. Bryer, Town Planner
Andrew J. Wade, Parks and Recreation Director
Donna Fogarty, Library Director
Mary Lou Sanborn, Library Trustees Chair
Peter D. Ruggiero, Town Solicitor
Cheryl A. Fernstrom, Town Clerk

II. CALL TO ORDER, PLEDGE OF ALLEGIANCE

President White called the regular meeting of the Jamestown Town Council to order at 7:04 p.m. in the Jamestown Town Hall Rosamond A. Tefft Council Chambers at 93 Narragansett Avenue and led the Pledge of Allegiance.

A Moment of Silence was observed in memory of President “41” George H. W. Bush.

**III. TOWN COUNCIL SITTING AS THE BOARD OF
WATER AND SEWER COMMISSIONERS**

None.

**IV. ACKNOWLEDGEMENTS, ANNOUNCEMENTS, PRESENTATIONS,
RESOLUTIONS AND PROCLAMATIONS**

A) Proclamation; review, discussion and/or potential action and/or vote

1) No. 2018-09: Honoring Probate Judge J. Peter McGuirl

The Proclamation was read by President White.

A motion was made by Vice President Meagher with second by Councilor Beye to adopt the Proclamation.

Discussion. Vice President Meagher noted she was on the Council in 1991 and made the motion to appoint Peter McGuirl as Probate Judge. When Peter served on the RI Turnpike and Bridge Authority as Chair he led RITBA into adopting the highway between the two bridges, which is part of the reason the highway is so well landscaped and maintained.

Back to the vote on the motion. **President White, Aye; Vice President Meagher, Aye; Councilor Beye, Aye; Councilor White, Aye; Councilor Piva, Aye.**

V. PUBLIC HEARINGS, LICENSES AND PERMITS

None.

VI. OPEN FORUM

A) Scheduled request to address.

- 1) Mary Lou Sanborn – congratulations to Members of the Town Council

Mary Lou Sanborn of Bay View Drive, Library Board of Trustees Chair, congratulated the new Town Council on behalf of the Library Board of Trustees and invited them to tour the Library and view the current building renovation plans. The annual report and updated strategic plan can be viewed on the Library website. The renovation plans are in the final stage of design development, and upon approval will be presented to the Council.

B) Non-scheduled request to address.

Charlotte Zarlengo of Seaside Drive congratulated the new Town Council and stated she is in attendance on behalf of Jamestown Shores President Ann Gagnon and all Shores Association members regarding the 34 lots they thought were protected in perpetuity. Their area sought for high development is no longer a summer community, leaving less room for groundwater protection. This is a crisis that will continue until there is protection, and water problems in the Shores adversely affects the entire Town. She urges the Council to protect the 34 Shores lots and put aside funds for future purchase of lots for groundwater protection. The Water Resources Protection Committee is under review, and the Shores Association would like one of their members appointed to the Committee. Thank you.

Vice President Meagher suggested Communication 4) from Ann Gagnon be addressed at this time. At the request of the Council, Town Planner Lisa Breyer reviewed the 34 lots proposed for protection for possible affordable housing lots. Planner Bryer will report on this at a future meeting.

Sav Rebecchi of Sail Street wants to recognize the advocacy group Upper Shores Advocates. There are 900 homes in the Shores, and 700 to 800 of them are not represented by the Shores Association and do not speak for all residents of the Shores. The Upper Shores Advocates would like their issues to be heard as well. Thank you.

**VII. COUNCIL, ADMINISTRATOR, SOLICITOR,
COMMISSION/COMMITTEE COMMENTS & REPORTS**

A) Town Administrator's Report: Andrew E. Nota

1) East Ferry Project Review

Town Administrator Nota provided a two-page status update focusing on Phases 1, 2 and 3. Discussion involved the funding element, which includes:

- State of RI Commerce Corporation Grant \$ 65,000
- RIDEM Grant For Pump-out Renovations \$ 10,000
- Waterfront Reserve Funds \$325,000-\$350,000
- Harbor Commission Capital Funds \$ 30,000
- Total Project costs \$400,000-\$450,000

The East Ferry Project is not funded with taxpayer dollars.

Public Works Director Michael Gray gave an update on the work performed by Cardi Corporation and Town staff over the spring and fall. The goal was to complete the project by Thanksgiving, but it was held up by heavy rains. Work included removal of the old concrete sidewalks and installation of crosswalks; the parking lot was left with binder material and temporary striping for winter and with guardrails installed to protect the benches; and the project will resume in the spring. A Grant received through the Harbor Office will fund rebuilding the pump-out, with work by Town staff. The sidewalk along the condo building by Grapes and Gourmet, Island Realty, and CMS was repaired along with the Town project and paid for by the business owners. Cardi should be commended for the work completed prior to the Tree Lighting.

President White thanked the Town Administrator for the new set-up for the Christmas Tree Lighting and additional space provided. Vice President Meagher noted the new sidewalks look great. It has been 40 years since the sidewalks, paving and landscaping were done and the new northern sidewalk behind the bus stop should be completed later this week. Discussion ensued of the interest for a dedicated brick or paver program at East Ferry.

2) Town Council On-boarding Program

Town staff is putting together a more formal program with binders, with an update of activities by department that should be ready in the coming weeks. A tour of Town facilities will be coordinated for December or January. Professional staff is here to answer questions.

3) Preliminary Budget Work Session Schedule

Mr. Nota stated the budget development process has commenced, and the FY 2019-2020 capital and operating budget memorandum to Town staff dated November 14th is attached to this report. Town department heads meet with the Town Administrator to review their budgets beginning in January and the proposed Town Administrator's budget is submitted to the Council 90 days prior to the FTM, followed by public budget work sessions for the capital, operating, and school budgets, with Town Council budget adoption required 30 days prior to the FTM. Discussion ensued.

VIII. UNFINISHED BUSINESS

None.

IX. NEW BUSINESS

- A) Upcoming meetings, work sessions, budget work sessions, workshops, and other sessions; review and discussion and/or potential action and/or vote
- 1) Town Council Meeting date and time
 - 2) Board of Water and Sewer Commissioners Meeting date and time

President White noted meetings can be changed as needed and have been the first and third Monday of the month, with Water and Sewer on the third Monday as part of the regular meeting. Councilor White proposed the July meeting be on the first Monday. Discussion ensued.

A motion was made by Vice President Meagher with second by Councilor Piva to continue with the current schedule of the first and third Monday of the month. President White, Aye; Vice President Meagher, Aye; Councilor Beye, Aye; Councilor White, Aye; Councilor Piva, Aye.

- 3) Annual Budget Work Session with Jamestown School Committee and School Department, pursuant to RIGL §16-2-21

This takes place in December and is tentatively scheduled for December 17th at 6:00 p.m. prior to the next scheduled meeting.

- 4) Town Council Tour of Town Facilities

President White would like the tour, using the Parks and Recreation bus for transportation, and can be done on multiple days if needed. Councilor Piva would like the Ambulance Barn and the Fort Wetherill Barn included in the tour.

- B) Town Council Liaison positions; review, discussion and/or potential action and/or vote
- 1) Jamestown School Department Liaison
 - 2) Jamestown Philomenian Library Liaison
 - 3) Jamestown Conservation Commission Liaison

The three liaison positions were appointed by the last Council and other liaison positions can be included on a future agenda for review and/or vote. The intent of the liaison positions is to facilitate communication and share information prior to receipt of approved board/commission/committee Minutes. This will be addressed at a future meeting with a full list of committees.

Sav Rebecchi of Sail Street stated meeting videos began in 2009, and liaisons were not used as much as the videos were available.

- C) Town Council Appointed positions:
 - 1) Town Solicitor/Prosecutor; review, discussion and/or potential action and/or vote
 - a) Letter of request from Peter D. Ruggiero of Ruggiero, Brochu & Petrarca for reappointment as Town Solicitor and Prosecutor, with background information

Vice President Meagher would like to continue with current Solicitor Ruggiero, Brochu & Petrarca. They have been terrific, serve as Solicitors for other RI communities, are a great resource, and have served the Town admirably. This position serves at the pleasure of the Council and can be revisited at any time.

Councilor Piva noted his agreement with Vice President Meagher; however, we have a letter of interest and resume from Jamestown firm Archer & Foppert and they should be given them the opportunity for an interview. Councilor White agreed. Their prosecution experience was not outlined in their (unsolicited) letter of interest and resume.

A motion was made by Councilor White with second by Councilor Piva to interview Archer & Foppert. President White, Aye; Vice President Meagher, Aye; Councilor Beye, Aye; Councilor White, Aye; Councilor Piva, Aye.

- 2) Probate Judge; review, discussion and/or potential action and/or vote
- 3) Town Sergeant; review, discussion and/or potential action and/or vote

Fred Pease has verbally confirmed his interest to continue as Town Sergeant.

A motion was made by Councilor Piva with second by Vice President Meagher to accept Fred Pease as our Town Sergeant. President White, Aye; Vice President Meagher, Aye; Councilor Beye, Aye; Councilor White, Aye; Councilor Piva, Aye.

- 4) Bond Counsel; review, discussion and/or potential action and/or vote

David Ferrara on behalf of Taft & McSally submitted a letter of interested to continue. The firm has served as Bond Counsel for over twenty years and does an excellent job. Their services are utilized as needed with no retainer.

A motion was made by Vice President Meagher with second by Councilor Beye to retain David Ferrara and Taft & McSally as bond counsel. President White, Aye; Vice President Meagher, Aye; Councilor Beye, Aye; Councilor White, Aye; Councilor Piva, Aye.

- D) Town Council Rules and Procedures; review, discussion and/or potential action and/or vote

- E) Town Council Goals and Objectives; review, discussion and/or potential action and/or vote

President White recommends we carry the Rules and Procedures and Goals and Objectives to a future agenda at a regular meeting or special session in January after Council review.

- F) Review of the Open Meetings Act, Access to Public Records Act, and Code of Ethics by Town Solicitor Peter D. Ruggiero

Solicitor Ruggiero explained the Open Meetings Act including:

- What is a quorum
- Conducting business outside of a duly called meeting
- Consensus the same as a vote
- Emails and what is allowed
- Use of electronic media
- Subcommittees
- Meeting postings and what is required

Solicitor Ruggiero referenced Title 42 Chapter 46 of the RI General Laws, Open Meetings (provided in the meeting packet), guidebooks available on the Attorney General's website, and Open Government Forums in January and August of each year. Notice of the sessions will be forwarded to Council by the Clerk. The Solicitor and Town Clerk are available to assist with any questions on Open Meetings.

Solicitor Ruggiero referenced Title 36 Chapter 14 of the RI General Laws, Code of Ethics. The RI Ethics Commission has publications on their website, and the regulations have doubled. Conflict of Interest and when to recuse were explained. A conflict exists if there is a financial benefit or loss affiliated with an issue for you or a member of your family, and a question of a conflict can be opined by the Solicitor. The only binding opinion is a written advisory opinion from the RI Ethics Commission, which may take four to six weeks. Discussion ensued of the Veterans Exemption issue before the previous Council. Solicitor Ruggiero explained the recusal procedure (forms are available at all meetings on the Council table). The reasons for an abstention and how that differs from recusal were explained. The Ethics Commission also conducts trainings and could do a workshop at Town Hall for Council and/or board/commission/committee members. Discussion ensued.

Solicitor Ruggiero referenced Title 38 Chapter 2 of the RI General Laws, Access to Public Records. Discussion ensued of documents and communications exempt from disclosure and subject to disclosure. Most correspondence and documents are subject to disclosure, except for the 27 exemptions listed in the Act (38-2-2. Definitions (4)). The Access to Public Records Act is also available on the Attorney General's website (included in the meeting packet).

Sav Rebecchi of Sail Street asked if Democratic Committee Meetings can be attended by three or more Council members. Solicitor Ruggiero noted political party meetings are exempt, but cannot be used to usurp the law, and discussion of Town business by Town Council members at such meetings would be a violation.

- G) Review, discussion and/or potential action and/or vote regarding a Grant of Easement by and between the Town of Jamestown and The Narragansett Electric Company through a portion of Town property located on Battery Lane designated as Plat 11 Lot 11 to provide electrical service to property located on Battery Lane designated as Plat 11 Lot 38, and authorization for signing by the Town Administrator

Town Administrator Nota explained the Easement and its development by Solicitor Wyatt Brochu in conjunction with National Grid. Language was modified to reflect that no aerial equipment will be used. Councilor White referenced Dennis Webster's concerns, appreciates the revisions, and asked if additional language should be included that any reconsiderations must come back to the Town for review and approval.

Jeff Hamlin, Battery Lane property owner, asked if this was the only change to the Easement language. Mr. Nota stated yes, and there can only be an underground connection. With the approval this evening, the Town Administrator can sign the Easement, it will be final, and connection can proceed. Mr. Hamlin asked if this could be continued to the next meeting so that he can review this further.

Councilor White noted the Waterfront Easement the Battery has and asked if this agreement would affect that. Town Planner Bryer displayed a map of the area and noted the Battery accesses their property through Town property. The strip of land referenced was originally used for underground communication cables by the Federal government. The subject area is overgrown. Discussion ensued.

A motion was made by Vice President Meagher with second by Councilor Piva to continue this to the next meeting. President White, Aye; Vice President Meagher, Aye; Councilor Beye, Aye; Councilor White, Aye; Councilor Piva, Aye.

X. ORDINANCES, APPOINTMENTS, VACANCIES AND EXPIRING TERMS

A) Ordinances

- 1) Presentation of certified initiative petition from Town Clerk concerning proposed adoption of Jamestown Sanctuary Ordinance, submitted pursuant to the relevant requirements of Sec. 219 of the Town of Jamestown Charter; review, discussion, and/or possible action to notice for public hearing and/or set down for submission to the electors for their approval or rejection, no less than 30 days nor more than one year from the date the town council takes its final vote thereon. The town council may, and if no regular election is to be held within such period shall, provide for a special election.

Solicitor Ruggiero summarized the Petition submitted to the Town Clerk that met the eligibility requirements of 454 signatures, with 455 certified signatures, with a proposed ordinance. Does the Council want to schedule a public hearing or go to a referendum? The Clerk provided a schedule of available dates for public hearing, noting conflicts. Solicitor

Ruggiero summarized actions that the Council can go to public hearing or referendum and an actual decision must be made within 30 days.

A motion was made by Councilor White with second by Vice President Meagher to schedule a public hearing on the earliest date available, the 13th.

Discussion. Councilor Piva noted this should go directly to referenda, as this has already taken a lot of the past Council's time. The Solicitor noted once the Canvassers certify signatures it triggers Council action. Councilor White stated the purpose of the public hearing would be to gain information why we are at this stage. The original ordinance that accompanied the signed petition was revised by the Working Group based on the Chicago Welcoming Ordinance. He asked why the petitioners went back to the original ordinance. He concurs with many of the sentiments contained in the initiative and the original ordinance and agrees with Conanicut Sanctuary's concern the current Federal administration is over-reaching on undocumented immigration. As a Prosecutor for 32 years he experienced first-hand the reluctance of undocumented victims of crime to come forward for fear of deportation. He is not persuaded that the proposed element relates to this community, and it is a solution in search of a problem. The JPD is bound by the US Constitution, it is difficult to be a police officer, and use of their discretion is one of their greatest tools. This proposed ordinance is directed at local police officers, does nothing about the over-reach of the Feds, and does nothing about the victimization of a vulnerable population. The local police have no interest in being deputized, as their responsibility is to our Town, and they don't want people hiding from them in fear of deportation. He feels there is no problem, and if there is a public hearing he would like to know of any incident in which a Jamestown Police officer conducted themselves in a way would have been in conflict with the proposed ordinance. The Federal government and the lack of a proper immigration policy is the problem. To direct police how to enforce the law is not proper. What is wrong with a resolution? Vice President Meagher noted many of her concerns were articulated by Councilor White. A public hearing would be advertised and the concerns of the community could be aired at the public hearing.

Public comment.

Sav Rebecchi of Sail Street noted he served on three Charter Commissions and Section 219 was reviewed at length. It is his opinion this would appear on a referendum ballot as a question "Shall the Town Council adopt an Immigration Protection Ordinance?" Many people who signed the petition stated they never saw the proposed ordinance.

Solicitor Ruggiero noted the Charter provision is ambiguous. The proponents of the petition represented orally to him and others in a meeting the proposed ordinance was provided with the petition. They gave the Clerk a written directive they were filing the signatures with the ordinance under the provisions of this Charter section. There are no pre-filing requirements, standards or criteria for acceptance or review of such provisions, and the Charter is silent in this area. The entire ordinance would appear on a referenda ballot as that is what was submitted. The Municipal Protection Ordinance for RI Cities and Town submitted was prepared by the ACLU. Vice President Meagher noted the Working Town Council Meeting

Group formed and options presented. This is the ordinance that would go forward as petitioned by Conanicut Sanctuary. Councilor White noted Section 219 is silent regarding discontinuation of a petition. Does that leave the legal possibility for withdrawal of the petition if signers of the petition rescinded their signatures? Solicitor Ruggiero stated as he reads it once this starts, it cannot be stopped. President White stated it is important for the Town to have a public hearing. Conanicut Sanctuary stressed if you do not agree with an ordinance, you are anti-immigrant, and he disagrees with that.

Back to the vote on the motion. **President White, Aye; Vice President Meagher, Aye; Councilor Beye, Aye; Councilor White Aye; Councilor Piva, Nay. Motion passes by a majority vote in the affirmative.**

The public hearing will be advertised for Thursday, December 13, 2018 at 6:00 p.m. Based on the Charter provision, if the ordinance is not approved, a referendum must be scheduled no less than 30 days nor more than a year from the date of the vote. The Board of Elections requires a minimum 50 days to prepare for a referendum. Councilor White asked if we know the cost of a special election. Town Administrator stated it would be between \$2,000 and \$3,000, based on one polling place.

Mr. Hamlin asked if the Battery Easement issue could be revisited this evening, and was informed there was a vote to continue to the next meeting, and it cannot be revisited at this time.

- B) Vacancies; review, discussion and/or potential action and/or vote
 - 1) Jamestown Affordable Housing Committee (Three Vacancies - One vacancy with a three-year term ending date of May 31, 2021, One vacancy with an unexpired three-year term ending date of May 31, 2020, and One vacancy with an unexpired three-year term ending date of May 31, 2019); duly advertised
 - a) Letters of resignation
 - i) Edie Flynn
 - ii) Lydia Thomas
 - iii) William J. Piva, Jr. – elected to Town Council
 - b) Letters of interest for appointment
 - i) Sydney Keen – for full term
 - ii) Fred Pease – for unexpired term
 - 2) Jamestown Fire Department Compensation Committee (One vacancy with a three-year term ending date of May 31, 2021); duly advertised
 - a) Letter of resignation
 - i) Jerome Scott
 - b) Letter of interest for appointment
 - i) Sydney Keen
 - C) Expiring Terms; review discussion and/or potential action and/or vote
 - 1) Beavertail State Park Advisory Board (One vacancy with a three-
- Town Council Meeting 12-03-2018 Page 9 of 17

- year term ending date of December 31, 2021); duly advertised
 - a) Term limit reached
 - i) Neil Blitz
 - b) Letter of interest for appointment
 - i) Linda Warner
- 2) Jamestown Conservation Commission (Two vacancies with three-year term ending dates of December 31, 2021); duly advertised
 - a) Letter of resignation
 - i) Bill Reardon
 - b) Letter of interest for reappointment
 - i) Phil Larson
 - c) Letters of interest for appointment
 - i) Jessica Wurzbacher
 - ii) Sydney Keen
 - iii) Susan Shim Gorelick
- 3) Jamestown Harbor Management Commission (Three vacancies with three-year term ending dates of December 31, 2021); duly advertised
 - a) Letters of interest for reappointment
 - i) Eric Lexow
 - ii) Wayne Banks
 - iii) Daniel Wurzbacher
 - b) Letter of interest for appointment
 - i) John Primiano
 - ii) Nicholas Radesca
- 4) Jamestown Housing Authority – Resident Commissioner (One vacancy with a five-year term ending date of December 31, 2023; duly advertised
 - a) Letter of interest for reappointment
 - i) Kathy Powers
- 5) Jamestown Juvenile Hearing Board – Member (Two vacancies with three-year term ending dates of December 21, 2021); duly advertised
 - a) Letter of resignation
 - i) Richard Mulcahey
 - b) Letter of interest for reappointment
 - i) Barbara Szepatowski
 - c) Letter of interest for appointment – to move up to Member from Alternate Member
 - i) Michael Lichtenstein
- 6) Jamestown Juvenile Hearing Board (Two alternate member vacancies with two-year term ending dates of December 31, 2020); duly advertised
 - a) Letter of resignation
 - i) Cheryl Petrosinelli

- b) Letter of interest for appointment
 - i) Sydney Keen
- 7) Jamestown Philomenian Library Board of Trustees (Two vacancies with three-year term ending dates of December 31, 2021); duly advertised
 - a) Letter of resignation
 - i) Marianne Kirby
 - b) Letter of interest for reappointment
 - i) Mary Lou Sanborn
- 8) Jamestown Planning Commission (One vacancy with a four-year term ending date of December 31, 2022); duly advertised
 - a) Letter of interest for reappointment
 - i) Dana Prestigiacomio
 - b) Letter of interest for appointment
 - i) Richard Lynn
 - ii) Sydney Keen
 - iii) Erik Brine
- 9) Jamestown Traffic Committee – Member-at-Large (Two vacancies with three-year term ending dates of December 31, 2021); duly advertised
 - a) Letter of resignation
 - i) Melissa Mastrostefano
 - b) Letter of interest for reappointment
 - i) Vincent Moretti
 - c) Letter of interest for appointment
 - i) Valerie Southern
- 10) Jamestown Tree Preservation and Protection Committee (Four vacancies with One unexpired three-year term ending date of December 31, 2019 and Three three-year term ending dates of December 31, 2021); duly advertised
 - a) Letter of resignation (unexpired term)
 - i) Richard Lynn
 - b) Letters of resignation (full terms)
 - i) Peter Kallman
 - ii) Mark Girard
 - c) Letter of interest for reappointment
 - i) Elaine Peterson
- 11) Jamestown Zoning Board of Review – Member (One vacancy with a five-year term ending date of December 31, 2023); duly advertised
 - a) Term limit reached
 - i) Richard Boren
 - b) Letter of interest to be appointed to full Member
 - i) Lisa Hough – 2nd Alternate
- 12) Jamestown Zoning Board of Review – Alternate Member (Three vacancies with one-year term ending dates of December 31, 2019);

duly advertised

- a) Letter of interest to remain as Alternate Member
 - i) Judy Bell – 1st Alternate
- b) Letter of interest for appointment
 - i) Erik Brine

Vice President Meagher asked if this could be continued. We do not have information on present committee members and new applicants, and in the past we have conducted interviews, which is most helpful.

Discussion ensued of making an appointment under X. C) Expiring Terms 1) Beavertail State Park Advisory Committee.

A motion was made by Councilor Piva with second by Vice President Meagher to have Linda Warner appointed to the Beavertail State Park Advisory Board. President, White, Aye; Vice President Meagher, Aye; Councilor Beye, Aye; Councilor White, Aye; Councilor Piva, Aye.

Under C) Expiring Terms 4) Housing Authority – Resident Commissioner. This position must be filled by a resident of a Housing Authority property.

A motion was made by Councilor Piva with second by Vice President Meagher to reappoint Kathy Powers to the Jamestown Housing Authority. President, White, Aye; Vice President Meagher, Aye; Councilor Beye, Aye; Councilor White, Aye; Councilor Piva, Aye.

Under C) Expiring Terms 7) Jamestown Philomenian Library Board of Trustees.

A motion was made by Councilor Piva with second by Vice President Meagher to reappoint Mary Lou Sanborn to the Library Board of Trustees. President, White, Aye; Vice President Meagher, Aye; Councilor Beye, Aye; Councilor White, Aye; Councilor Piva, Aye.

A motion was made by Vice President Meagher with second by Councilor Beye to move the rest of these to the December 17th meeting. President, White, Aye; Vice President Meagher, Aye; Councilor Beye, Aye; Councilor White, Aye; Councilor Piva, Aye.

XI. CONSENT AGENDA

Explanation of the Consent Agenda proceeded. Exceptions are removed by request of a Council Member. Councilor White asked about the Zoning abutter notifications on the agenda after the public hearing has taken place. He was informed the notifications are on the agenda for Council information.

A motion was made by Vice President Meagher with second by Councilor Beye to approve and accept the Consent Agenda. President White, Aye; Vice President Meagher, Aye; Councilor Beye, Aye; Councilor White, Aye; Councilor Piva, Aye.

The Consent Agenda approved consists for the following:

- A) Adoption of Town Council Minutes
 - 1) November 19, 2018 (special meeting)
- B) Minutes of Town Boards/Commissions/Committees
 - 1) Jamestown Harbor Commission (05/09/2018)
 - 2) Jamestown Harbor Commission (06/13/2018)
 - 3) Jamestown Harbor Commission (07/11/2018)
 - 4) Jamestown Harbor Commission (08/08/2018)
 - 5) Jamestown Harbor Commission (09/12/2018)
 - 6) Jamestown Library Board of Trustees (10/09/2018)
 - 7) Jamestown Library Building Renovation (10/02/2018)
 - 8) Jamestown Planning Commission (09/19/2018)
 - 9) Jamestown Planning Commission (10/03/2018)
 - 10) Jamestown Planning Commission (10/17/2018)
 - 11) Jamestown Zoning Board of Review (10/23/2018)
- C) CRMC Notices
 - 1) Semi-Monthly Meeting Agenda for November 27, 2018
 - 2) Official Finding and of Violation to Makenzie and Brittany Richards for mowing an emergent wetland for the property located at Arnold Avenue described as Plat 8 Lot 890
- D) Zoning Board of Review Abutter Notifications: Notice is hereby given that the Jamestown Zoning Board of Review will hold a Public Hearing on November 27, 2018, at the Jamestown Town Hall, 93 Narragansett Avenue, Jamestown, RI, at 7:00 p.m. upon the following:
 - 1) Application of Angels Kitchen, whose property is located at 23 Narragansett Ave., and further identified as Assessor's Plat 9, Lot 568 for a special use permit from Article 6, Section 82-601, Special Use Permits authorized by this ordinance, Article 3, Table 3.1 Restaurant with Alcohol, to serve beer & wine. Said property is located in a CL zone
 - 2) Application of Donata & Neill Barber, whose property is located at 108 Howland Ave., and further identified as Assessor's Plat 9, Lot 516 for a variance & special use permit from Article 3, Section 82-302, Table 2 – setback requirements, Article 14, Section 82-1403-H-Detached AFDU, Article 6, Section 82-601 & 606 Special Use Permits, conditions for granting a variance. Request minimum relief per articles to allow for an existing approved AFDU that is .8 ft. from the rear lot line instead of the required 30 ft. Said property is located in a R20 zone and contains 16,500 sq. ft.
 - 3) Application of Jamestown Beer Holdings LLC (Okema Prop. LLL, owner) whose property is located at 34 Narragansett Ave., and

further identified as Assessor’s Plat 8, Lot 453 for a special use permit from Article 3, Section 82-301, Table 3-1 VIB Tavern/Bar, Article 6, Section 82-601 special use permit to operate a nano-brewery and taproom. Said property is located in a CD zone and contains 1,373 sq. ft.

4) Application of Paul Hamilton and Patricia Young whose property is located at 260 Beavertail Road, Jamestown, RI, and further identified as Tax Assessor’s Plat 12, Lots 42 and 212, for an appeal pursuant to the Zoning Ordinance, Article 82, Section 408 (“Appeal of a decision of the zoning enforcement officer”). Mr. Hamilton and Ms. Young appeal the Zoning Enforcement Officer’s decision not to take action on their formal, written request that he take action with respect to their neighboring property owner’s (Geoffrey Hamlin and Kristan Peters Hamlin, together, the “Hamlins”) tennis court structure (located at 0 Battery Lane, Tax Assessor’s Plat 11, Lot 38), specifically to:

1. Require complete removal of the tennis court structure and regrading of the area to preconstruction elevations as reflected in the existing plans;
2. Formally deny the November 6, 2017 Northeast Engineers & Consultants, Inc. drainage plan (entitled “Proposed Improvements in the Vicinity of Tennis Court”) submitted by the Hamlins, because, for one, it is an “after-the-fact” plan that is not appropriate under the soil erosion and sedimentation provisions of the Town Code; and
3. Require the Hamlins to submit an appropriate drainage plan, if still necessary for the work proposed on the whole of the Hamlins’ property.

Paul Hamilton and Patricia Young’s property is located in an RR-80 zone and contains approximately 45.195 acres.

E) Abatements/Addenda of Taxes

Total Abatements: \$69,626.87 Total Addenda: \$73,966.00

1) Motor Vehicle Abatements to 2018 Tax Roll

Account/Abatement Amount

- | | | |
|----|-------------|-----------|
| a) | 07-1131-01M | \$ 35.50 |
| b) | 07-1131-02M | \$ 167.59 |

2) Real Estate/Tangible Property Abatements to 2018 Tax Roll

Account/Abatement Amount

- | | | |
|----|------------|-------------|
| a) | 01-0696-97 | \$ 3,498.94 |
| b) | 02-0317-50 | \$17,087.06 |
| c) | 03-1105-80 | \$11,291.53 |
| d) | 03-1302-52 | \$ 6,711.49 |
| e) | 03-1496-00 | \$ 6,723.88 |
| f) | 04-0035-00 | \$ 106.20 |

	g)	08-0095-50	\$10,794.44
	h)	08-0862-00	\$ 3,394.96
	i)	16-0680-05	\$ 5.31
	j)	19-0009-10	\$ 7,697.83
	k)	20-0505-75	\$ 2,112.14
3)		Addenda to 2018 Tax Roll	
		<u>Account/Abatement Amount</u>	
	a)	03-0590-60	\$ 612.76
	b)	04-0015-52	\$ 1,566.34
	c)	04-0668-30	\$ 6,723.88
	d)	06-0302-70	\$ 1,750.18
	e)	07-0592-73	\$ 3,544.96
	f)	07-1034-00	\$17,087.06
	g)	10-0364-10	\$11,291.53
	h)	10-0410-10	\$ 2,112.14
	i)	12-0901-85	\$10,944.44
	j)	13-1734-00	\$ 274.45
	k)	13-1780-55	\$ 7,847.83
	l)	13-1965-50	\$ 3,498.94
	m)	23-0556-00	\$ 6,711.49

XII. COMMUNICATIONS, PETITIONS, AND PROCLAMATIONS AND RESOLUTIONS FROM OTHER RHODE ISLAND CITIES AND TOWNS

Vice President Meagher noted Ann Gagnon’s letter was addressed previously. The first three Communications are from the Conservation Commission: 1) deals with the Water Resources Protection Committee and should be agenda item at a future meeting; 2) regards the proposed parking area for the Conanicut Island Sanctuary Trail and it would be helpful to see a plan; 3) paper streets sounds like a big discussion and should be an item on a future agenda; 6) the Veterans Exemption letter submitted by Denis Webster should be on the second meeting in January; and 7) email from Ken Nelson requesting a stop sign should be forwarded to the Traffic Committee.

Dennis Webster speaks to the veterans exemption and requests the Town Administrator and Tax Assessor present recommendations for enabling legislation and forwarded to Representative Ruggiero as early as possible as recommended. Once submitted there is time to review the amount of the exemptions. It is important for Council members to request an advisory opinion from Ethics Commission right away.

A motion was made by Vice President Meagher with second by Councilor Piva to receive the Communications. President White, Aye; Vice President Meagher, Aye; Councilor Beye, Aye; Councilor White, Aye; Councilor Piva, Aye.

The Communications, Petitions, and Resolutions and Proclamations from other RI cities and towns received consists of the following:

- A) Communications
- 1) Memorandum of Jamestown Conservation Commission re: Water Resource Protection Board and proposing WRPB operate independently from the Conservation Commission
 - 2) Memorandum of Jamestown Conservation Commission re: proposed parking area for the Conanicut Island Sanctuary Trail, as developed by Trail Steward Chris Powell
 - 3) Memorandum of Jamestown Conservation re: Jamestown Paper Streets and Citizen's access to water
 - 4) Letter of Ann Gagnon requesting the Town move immediately to protect the remaining 34 lots in the Shores for groundwater protection and over development
 - 5) Letter of the Barrington Town Council to the Middletown Town Council re: Superior Court decision concerning Flavored Tobacco Control Ordinance
 - 6) Letter of Arnold-Zweir Post 22 American Legion and Veterans of Foreign Wars Post 9447 requesting the Town Council review the tax credit initiated by the previous Town Council
 - 7) Email of Kenneth Nelson to Police Chief Mello requesting installation of a stop sign at the east/west intersection of Lawn Avenue and Watson Avenue to reduce vehicle speeding

XIII. AGENDA ITEMS FOR THE NEXT MEETING AND FUTURE MEETINGS

- A) Budget Work Sessions for FY 2019-2020
- B) Veterans Exemption Review
- C) Discussion on Future Improvements to the public East Ferry boat ramp
- D) Discussion regarding formation of a separate Water Resources Protection Committee
- E) Discussion regarding "Excess" classification of the Beavertail Lighthouse Property and future State and Local interest in the property
- F) Authorization to proceed to 100% design and bid document development on the Golf Course Clubhouse project.

Discussion involved the following:

- Veterans' Exemptions should be on an agenda as soon as possible.
- The Beavertail "excess" classification should be on a January agenda, with members of the Beavertail Museum Group invited. The process was stalled due to lead remediation, and once this is rectified, the process will be accelerated.
- Complaint of a resident regarding parking at Mackerel Cove should be kept in the fore front.
- Fort Getty fees will be on the next agenda prior to sending renewals to campers.
- The proposed Department of Seniors will be on an upcoming agenda.

XIV. EXECUTIVE SESSION

None.

XV. ADJOURNMENT

A motion was made by Councilor Beye with second by Councilor White to adjourn. President White, Aye; Vice President Meagher, Aye; Councilor Beye, Aye; Councilor White, Aye; Councilor Piva, Aye.

The Jamestown Town Council adjourned the regular meeting at 9:18 p.m.

Attest:

Cheryl A. Fernstrom, CMC, Town Clerk

Copies to: Town Council
 Town Administrator
 Finance Director
 Town Solicitor

**TOWN COUNCIL SPECIAL MEETING
December 13, 2018**

I. ROLL CALL

Town Council Members present:

Mary E. Meagher, Vice President
Nancy A. Beye
Randall White
William J. Piva, Jr.

Town Council Members absent:

Michael G. White, President

II. CALL TO ORDER, PLEDGE OF ALLEGIANCE

Vice President Meagher called the special meeting of the Jamestown Town Council to order at 6:04 p.m. in the Jamestown Town Hall Rosamond A. Tefft Council Chambers at 93 Narragansett Avenue and led the Pledge of Allegiance.

Vice President Meagher noted President White is not in attendance due to illness.

III. PUBLIC HEARINGS, LICENSES AND PERMITS

A) Public Hearing:

- 1) Proposed Amendment of the Jamestown Code of Ordinances, to include a Municipal Immigrant Protection Ordinance as submitted pursuant to the provisions of Section 219 of the Town of Jamestown Town Charter; duly advertised in the *Jamestown Press* December 6th edition; review, discussion and/or potential action and/or vote

A motion was made by Councilor Piva with second by Councilor Beye to open the Public Hearing at 6:05 p.m. President White, Absent; Vice President Meagher, Aye; Councilor Beye, Aye; Councilor White, Aye; Councilor Piva, Aye.

Vice President Meagher read the Preamble to the proposed Municipal Immigrant Protection Ordinance. Copies of the proposed ordinance have been available at Town Hall, Jamestown Library, Town website, and on the table at the back of the Council Chambers. The ordinance is before the Council pursuant to Section 219 of the Jamestown Town Charter, as read by Vice President Meagher. On November 27th the Board of Canvassers confirmed that 455 qualified registered voters signed the petition that accompanied this ordinance, comprising the required 10% of registered voters, and on November 30th the Town Clerk certified the initiative petition. At its meeting of December 3rd the Town Council set this public hearing date. She thanked the Canvassers, Clerk, Administration and Solicitor for their professional

handling of the petition and ordinance. The Council is calling this public hearing to provide a forum for discussion of the ordinance so that the Council can decide if they want to act on the ordinance. If approved by Council exactly as presented by Conanicut Sanctuary, this ordinance will not proceed to a referendum. However, if the ordinance is not adopted as presented, per the Town Charter this ordinance will proceed to a referendum election within the next twelve months. We are here to discuss the particulars of the proposed ordinance and all comments are to be directed to the ordinance. To address comments to the Town Council please raise your hand to be recognized, come up to the podium, and state your name and address. We all need to be polite and respectful of one another and be concise in our comments.

We will hear first from the petitioners, then the Police Chief, followed by Town Council members, and then comments from the public. After the comments are heard the Council will make a decision on the ordinance itself and if necessary the date of the referendum

Conanicut Sanctuary representative Helen O'Grady thanked the Council for this opportunity. They are here to address Version 1 of the Ordinance. However, there were three versions of the ordinance and Section 219 of the Town Charter allows Council to adopt any of these versions.

Vice President Meagher asked for the Solicitor's opinion on that statement. Solicitor Ruggiero stated the way the Charter Section is written only the ordinance the signatories viewed when signing the petition is the version that must go forward, in his opinion. Vice President Meagher stated we are considering the ordinance submitted with the petition.

Helen O'Grady of Schooner Avenue noted Conanicut Sanctuary, referred to as CS, supports any of the three versions. Vice President Meagher asked Ms. O'Grady to focus on the original version. Ms. O'Grady stated the original version was drafted by the New York State Attorney General's Office and distributed by the ACLU. This version is in compliance with Federal and State law and does not violate the Town Charter, as refuted by Immigration Attorney Carl Kruger. The proposed version will keep civil immigration enforcement and criminal law enforcement disentangled, allowing our Police Department to focus on criminal law enforcement. Explanation and discussion ensued of defined access, due process, judicial warrant, and probable cause contained in the proposed ordinance to ensure that immigrants in custody of the Police Department are subject to the same practices as any other citizen.

References to components of the ordinance proceeded, including dialogue at meetings with Chief Mello in March 2017, June 4, 2018, and meetings of the Jamestown Sanctuary Working Group. SC is trying to keep our Police Department out of the business of enforcing Federal immigration law and ensure that all people are treated the same. Various sections of the proposed ordinance were reviewed with examples and explanation of judicial warrant, Federal warrant, administrative warrant, and civil warrant. Discussion ensued of the South Kingstown Ordinance and State Police Policy/Ordinance and that they are in line

with the Jamestown Resolution adopted in 2017. Ms. O'Grady noted the majority of immigrants are law abiding, hard-working members of the community and if deported would be subject to human rights violations. This ordinance would keep us all safer, would not protect violent criminals, and would not prohibit Jamestown Police from cooperating with Federal and State agencies, allowing them to focus on local criminal law enforcement.

Lengthy discussion ensued, including comparison of the value of a Resolution vs. an Ordinance. This is about trust and a policy, not judging an individual's or police department's character. This is about confidence and being able to contact the police without fear of deportation. An ordinance has more teeth, can be enforced, and allows our Police Department to protect all.

Police Chief Edward Mello addressed the meeting, offering his perspective on the proposed ordinance, with review by Section.

Section 1. Limitation on activities solely for the purpose of enforcing federal immigration laws.

Chief Mello has no concern with 1 (a) and 1 (b). Section 1 (c) would completely restrict cooperation with Federal agencies for all immigration matters including those involving serious crimes and where a Federal immigration warrant has been issued.

Section 2. Conditions for honoring ICE or CBP detainer requests.

Chief Mello has concerns that Sections 2 (a) and (b) would limit cooperation with Federal officials to matters in which a Federal immigration warrant has been issued or the individual has been engaged in terrorist activities and would now allow discretion by police to cooperate with Federal officials regardless of the significance of the crime committed in Jamestown or previous criminal activity. Even in cases where an individual has a long criminal history, is subject to a civil detainer, and commits a crime in Jamestown, this section would prevent cooperation with Federal officials regardless of the nature or circumstances of the crime or criminal history.

Section 3. Limitations on honoring ICE or CBP requests for certain non-public, sensitive information.

Chief Mello has concerns Section 3 would limit information provided to immigration officials beyond what is currently public information as provided in RIGL § 38-2-3.2.

Section 4. Limitations on ICE or CBP access to individuals in custody for immigration enforcement questioning purposes.

Chief Mello has concerns Section 4 would limit cooperation with Federal officials to matters in which a Federal immigration warrant has been issued and would not allow discretion by police to cooperate with Federal officials regardless of the significance of the crime committed in Jamestown or previous criminal activity. Even in cases where an individual has a long criminal history, is subject to a civil detainer and commits a crime in Jamestown, this section would prevent cooperation with Federal officials regardless of the

nature or circumstances of the crime.

Section 5. Due process for persons about whom federal immigration enforcement requests have been made.

Chief Mello has no concerns with Sections 5 (a) (1). Section 5 (a) (2) would not allow discretion by police to cooperate with Federal officials regardless of the significance of the crime committed in Jamestown or previous criminal activity. Even in cases where an individual has a long criminal history, is subject to a civil detainer and commits a crime in Jamestown, this section would prevent cooperation with Federal officials regardless of the nature or circumstances of the crime. There is no concern with sections 5 (b) and 5 (c).

Section 6. Ban on use of resources to facilitate a Federal registry based on race, gender, sexual orientation, gender identity or expression, religion, ethnicity, or national origin.

Chief Mello has no concern with Section 6.

Section 7. Limitation on the collection of immigration-related information; provision of nondiscriminatory access to benefits and services.

Chief Mello has no concern with section 7 (a). The Police Department is currently finalizing the policy to address section 7 (b).

Section 8. Limits on Political Surveillance.

Chief Mello has no concern with section 8.

Section 9. Protecting Immigrant Victims of Crime.

Chief Mello has no concerns with Section 9. South Kingstown did not include this entire section within their adopted ordinance.

Section 10. Protecting the Rights of Students.

Chief Mello noted Section 10 doesn't apply to the Jamestown Police Department.

Section 11. Collection of aggregate data regarding ICE and CBP requests.

Chief Mello noted there are no concerns with Section 11. South Kingstown did not include this entire section within their adopted ordinance.

Section 12. Enforcement.

Chief Mello referred to the Town Solicitor.

Section 13. Affirmation of Compliance with Federal Law.

Chief Mello commented there are no concerns with Section 13.

Section 14. Definitions.

Chief Mello noted Section 14 does not contain all terms used throughout the document including but not limited to “federal judicial order” which is not listed.

Section 15. Severability.

Chief Mello noted the Police Department encounters many individuals all year. No inquiry is made as to their citizenship nor do they make any inquiry to federal officials. This would only occur when someone is taken into custody and they are fingerprinted, as are all individuals taken into custody. His concern is the limitation of cooperation regarding someone in custody who is of interest to Federal officials under a judicial warrant.

Councilor White expressed concern whether the 500 people who signed the petition are aware of what they actually signed. The petition referred to an ordinance and there has been discussion of three ordinance versions over time. He holds dearly the emotion that accompanies aggressive Federal immigration policies. Do they know what led up to this evening’s public hearing and were other options noted to the petition signers? Reasonable minds can differ on how to approach an issue and a policy or resolution could be implemented to address it. The State Police operate on their good faith and conscience, as they only react to a Statute, as do our police officers. If you can trust the State Police why can’t you trust the Jamestown Police to act appropriately? CS stated an ordinance has teeth, but he heard no concern with the conduct of the Jamestown Police. The ordinance enforcement provision allows only certain parties to bring suit, which is not a rational approach to a national problem that needs to be addressed by our Congressional delegation. We should not take a reactionary approach to a problem that is not here.

Vice President Meagher opens the meeting to comments from the public.

Mary Katherine O’Neill of North Main Road noted she has family members who are naturalized citizens, she belongs to a non-profit organization that has many members who are naturalized citizens, and she is 100% opposed to the ordinance. Immigration law is criminal law under US Criminal Code 8, and conspiracy to harbor is criminal. Regarding the fear that our Police Department would be deputized to enforce immigration law, ICE is charged with such enforcement, and no local agency can enforce immigration law unless officials have a Memorandum of Agreement under 287 G. She is concerned there are a number of ordinance versions.

Vice President Meagher noted this public hearing addresses the version presented with the petition.

Ms. O’Neill stated immigrants are not in violation of law, are residents, have green cards, and have rights afforded them. The Ordinance fails to comply with our Town Charter, in her opinion, fails the due process requirement, and has no penalties. Ms. O’Neill submits a document, which is accepted as Exhibit 1.

Jean Spinoza of Southwest Avenue shared her experience regarding the signing of the petition. She was outside her home and asked to sign a petition. She asked if this would

make Jamestown a Sanctuary City and was told yes. At that time she was not shown an ordinance. She asks the Council to put this on a referendum so that all citizens have the opportunity to cast their vote.

Hugh Murphy of Stern Street stated he is a member of the Board of Canvassers. This meeting should not have happened. The Charter states that only petitions with at least 10% of registered Jamestown voters are to be considered. The Canvassers were charged with validating signatures on two different petition forms and determined there were 456 valid signatures. On the first one 403 signatures compared to voter registration forms were determined to be valid, and he concurred. The second form had 53 names of registered voters but had no signature block, and the vast majority of the names were printed and not signed. The printed names were accepted by the other two members of the Board of Canvassers as valid, which brought the total validated signatures to 456, one more than required. A printed name is not a signature, is unique, and can be validated. The 53 printed names cannot be validated, and this petition process is legally flawed and should be declared invalid per the Town Charter. The proposed ordinance would be an open invitation to any illegal alien to roam free in Jamestown. He works for the Navy and we are instructed if we see something say something. An illegal alien could set up shop in Jamestown and spy on the Navy. This is a threat to national security, and if he hears that illegal aliens are harbored here in Jamestown, he would notify federal authorities, and urged citizens to do the same.

Councilor Piva asked what guidance the Board of Canvassers followed, as he saw there were printed names that did not have signatures.

Carol Nelson Lee of Buoy Street, Chair of the Board of Canvassers, stated the Board carefully looked at the Charter and found the Section related to voter initiative and the requirement at least 10% of the voters registered at the last general election, which would be the 2016 election, had to sign. Six months had passed since the signing of the petition to when it was reviewed. One person moved away and one had died, and their signatures were accepted as they were registered voters at the time of signing. There were two formats for the petition, and we looked at the Charter and carefully looked at the format, checked for registered voters and that signatures matched. The signature page in one petition did not have a place for signature and printed name. We had to look at intent, and that came down to a 2 to 1 vote to accept the names. For the second group we found that a number of the names were signed and not printed.

Vice President Meagher asked the Solicitor whether this is acceptable.

Solicitor Ruggiero stated the Board of Canvassers met and they took a vote, and anyone could have appealed their decision, and it was not appealed at that time. The matter was certified and the process in place, and it is improper to question it and derail the process. We all struggled with this, there is no checklist for what is required, and all did their best. Discussion ensued of the 32 printed names accepted.

Michael Montoya of Lawn Avenue stated he was surprised this has gotten this far. He has a legal background, and it took him hours to review this. Enforcement in Section 12 in the ordinance drafted by the ACLU allows the ACLU to sue for any violation. In Section 10 the School Department has to set up a policy to protect students from interaction with Federal officials. The statement by Councilor White this is a solution to a problem that doesn't exist is correct. Why set ourselves up to be sued. In Los Angeles or Providence this may be needed, but not in Jamestown. [Applause]

Peter Coble of Narragansett Avenue congratulated the new Town Council. He showed his Certificate of Citizenship; he was an immigrant and has no problem as long as people do it legally. He referenced newspaper articles about 58 illegal aliens being rounded up and the crimes, including murder, committed by some of those immigrants. He feels the proposed ordinance handcuffs the police, not the illegals, sets us up for a lawsuit, and is not a good idea. [Applause]

Keith Stavely of Capstan Street stated he will submit a statement for someone not here and that he is in favor of the ordinance. President Trump claims the majority of undocumented immigrants are guilty of serious crimes. This is not true, and the non-citizen crime rate is lower than that of citizens. President Trump reversed the Obama policy in order to make good on his promises. The Administration is keeping out new immigrants no matter what and enforcing the discriminating policies of the 1920's. Do we want JPD to cooperate with fraudulent and abusive policies? We have been assured Jamestown will not participate in Federal enforcement. Almost 500 registered voters considered this worthy of enacting as an ordinance. We need to take a stand, and he urges enactment of the ordinance.

Mr. Stavely submits the statement of Cynthia Long Ratteron of Capstan Street, who is unable to attend. It states she has admiration for JPD and Chief Mello and that there is nothing in the ordinance that would prevent JPD from cooperating with ICE when there is a violent criminal. We are not helping ICE and this ordinance is not in conflict with the US Constitution, and local law enforcement should adopt the same protocols as the State Police and Department of Corrections. Nothing contained in the ordinance would limit a police officer's reach when arresting someone who has committed a crime. She prefers that JPD not be complicit in separating families. Discussion continued.

Terry Glenn of Neptune Street stated he is a new resident and is against the ordinance as it will deter police officers from doing their job. He is a 31 year military veteran, having been deployed to 71 countries around the world. San Francisco was the gem of the country and is now a Sanctuary City, and residents are leaving there in droves. He is appreciative of law enforcement and against something that will tie the hands of law enforcement. [Applause]

Perry Scott of Top 'O Mark Drive stated he is fascinated by the discussion of signatures. He has lived here two decades and brags about the safety and caring of the community, and

this is not about illegal aliens. He is against the ordinance. He doesn't bother immigrants. Do we have to support a group that doesn't have legal status? [Applause]

Vice President Meagher stated 32 printed names were accepted by the Board of Canvassers and it was their decision working in sincerity and on our behalf. You may disagree, but they are doing the best job possible and she acknowledges the efforts made. Objections should have been made then.

Richard Hitt of Schooner Avenue thanked the Council for this opportunity. He supports the ordinance and it is not an answer to immigration reform that must be addressed on the Federal level. The President has demonized immigrant members of our population with misinformation, which is why we want the immigrant protection ordinance adopted. Myths about immigrants were noted and clarified. Undocumented immigrants are less likely to commit crimes, have lower crime rates in immigrant populated areas as proven by studies, immigration does not equal more crime, and immigrants have contributed to our society. Our immigrant community cannot trust they are safe and we need to give our community of immigrants a reason to trust and give assurances they are safe in seeking help and will be treated the same as any citizen. Achievements, accomplishments, and the overall good record of immigrant citizens were reviewed. Lengthy discussion continued. We need to give our immigrant community a reason to trust by adopting the proposed ordinance. Discussion continued.

Maria Carella of Bay View Drive commented her family were immigrants and came here to build the country not destroy it. This country made progress that would not have been possible without immigrants. She came here in 1961 through Argentina due to the free entrance agreement with the South America and settled at Nantasket Beach in Massachusetts. She noted the kindness she experienced when her family came to this country and how they prospered. We should not fear immigrants.

James Dunphy of Columbia Avenue stated he is insulted by this proposed ordinance. He loves and cares for the community, the ordinance proposed wasn't written for Jamestown, and the people who wrote it don't care about Jamestown. He trusts in this Council to conduct business out of love and care for our community. This is a mistake.

William W. Smith of Hull Cove Farm Road stated he was one of the people who circulated the petition and he spoke before the previous council. He has heard fear, anger and hatred regarding people who are different and don't belong. There is no such thing as an illegal person, it is not criminal to be in the USA without papers. It is a civil violation to live here without papers, and it is the job of the Federal government to oversee immigration. There is no law against coming to the USA without papers if seeking asylum or fleeing violence and persecution. The proposed ordinance in no way prevents JPD from arresting anyone who is a criminal or threat to our citizens. Let's make Jamestown a safer and more welcoming place by passing this ordinance.

Ken Lima of Columbia Lane stated he has been an attorney for 40 years. We have federal law, and we enforce the laws, as that is what our country was built on. The remedy to the problem is an excuse. If don't like the laws, work to reform the laws. People are welcomed to be citizens and follow the law and come here legally. Refugees from oppression are different. He respects those who want to change the law and not tie the hands of our law enforcement officers. [Applause]

Nancy Semco of Gondola Avenue stated she wants a community where she can love her neighbors, and we can only have that when we have the protection of the law. Illegal immigrants are coming here without vaccines and have a higher rate of diseases. If ICE has a judicial warrant or no warrant because they just got here and have a criminal record in another country, their records are skewed. Tuberculosis and other diseases that are drug resistant can be contracted anywhere. I trust the government to check immigrants when they enter this country, we can't enjoy the community if there are diseases, and we can't be in fear of the people we live with.

Sidney Keene of Walcott Avenue stated it is difficult for people to get status here and ICE has engaged in activities that are unfair. Though there are no issues with the Jamestown Police Department, a preventative measure is still warranted, and it is important to be proactive.

Stephen Anderson of Riptide Street stated the ordinance does not say Jamestown on it. He came here open-minded, but the ordinance ties the hands of our police officers, and he is not in favor of it. At some time immigration should be addressed. Immigrants come here for a reason and there is a process they go through. We can't live in fear of immigrants as at one time we were all immigrants.

Stefan Gislason of Beavertail Road stated we think this is a Jamestown issue and the recommendation is to deal with this on the state and Federal level, but they have failed to do so. It is important to pass this type of ordinance locally so that everyone should not fear traveling to another place and to assure people they can come here. We do need a codified ordinance to secure the rights of all and to send the message to the State House in order to get legislation passed on that level. The Town Council in South Kingstown passed the same ordinance and all is ok there and it does not violate the rule of law. He supports the ordinance and urges Council to adopt it.

A motion was made by Councilor Piva with second by Councilor Beye to close the Public Hearing at 8:13 p.m. President White, Absent; Vice President Meagher, Aye; Councilor Beye, Aye; Councilor White, Aye; Councilor Piva, Aye.

Vice President Meagher thanked everyone for their time. We tried to get everyone's voice heard this evening. She asks the Council's pleasure on how to proceed.

Councilor Piva stated he wanted to hear from CS real life Jamestown examples and perhaps

confrontations with or violations by Jamestown Police, and he heard none. He will not vote for this ordinance. He needed to hear the problem that happened locally that caused this to come before the Council. This is not a local issue and you don't pass an ordinance based on emotion. JPD has done an excellent job, they have a great Police Chief, and he has faith they will continue to do the same great job they do every day. [Applause]

Councilor Beye thanked everyone for coming and being patient and respectful. We are here this evening as Congress has failed to pass comprehensive immigration reform, causing 30 counties in 7 states to adopt some type of immigration protection ordinance. She appreciates the efforts and compassion of Conanicut Sanctuary. Voting in favor of this ordinance will go against the advice of our Police Chief and Town Solicitor, and that is why she will not vote in favor of this tonight.

Councilor White stated the ordinance proponents noted the ordinance seeks to protect the 11,000,000 million undocumented immigrants who are here and need additional protections. An ordinance that makes sense for Jamestown must address a real life situation and concern, and it is difficult to get people who are vulnerable to participate in the criminal justice system as victims or witnesses. Municipal police officers have a natural instinct not to cooperate with unnecessary enforcement of immigration laws as it affects their relationship with the community. They don't want to promote fear among our immigrant population who may be here in a vulnerable status. He has empathy for the efforts of CS. However, the proposed ordinance does not achieve what it sets out to do, and he opposes it.

Vice President Meagher commented on being one of the authors of the Resolution of 2017 that expressed support for House Bill 5515 regarding immigration enforcement on a statewide basis. It also opposed two bills that would have deputized local law enforcement and called for comprehensive immigration reform. Our Police Chief and Solicitor have raised significant questions on the proposed ordinance. She is voting against this ordinance as it places 13 local police officers in the difficult position of defying Federal law and in contradiction to their Oath to uphold Federal, State and local law. She commented on the work of the Sanctuary Working Group in trying to find an alternative, stated her appreciation for the work of Conanicut Sanctuary in gathering so many signatures, but disagrees with their unwillingness to accept anything other than an ordinance. She feels this should go to the voters.

A motion was made by Councilor Piva with second by Councilor White to reject the ordinance as presented by Conanicut Sanctuary. President White, Absent; Vice President Meagher, Aye; Councilor Beye, Aye; Councilor White, Aye; Councilor Piva, Aye.

B) Review, discussion and/or potential action and/or vote to set a date for a special referendum for a Proposed Amendment of the Jamestown Code of Ordinances, to include a Municipal Immigrant Protection Ordinance as submitted pursuant to the provisions of

Section 219 of the Town of Jamestown Town Charter, if needed; said referendum to be scheduled no later than December 3, 2019.

Discussion involved potential dates for a special referendum, noting April or September would work best.

A motion was made by Councilor Piva with second by Councilor Beye to set the date for April 2, 2019. President White, Absent; Vice President Meagher, Aye; Councilor Beye, Aye; Councilor White, Aye; Councilor Piva, Aye.

IV. COMMUNICATIONS

- A) Communications re: Proposed Municipal Immigrant Protection Ordinance; review, discussion and/or potential action and/or vote
 - 1) Letter of Donna Cote of Spindrift Street stating she is not in favor of Jamestown becoming a sanctuary city

V. ADJOURNMENT

A motion was made by Councilor Piva with second by Councilor White to adjourn. President White, Absent; Vice President Meagher, Aye; Councilor Beye, Aye; Councilor White, Aye; Councilor Piva, Aye.

The special meeting was adjourned at 8:25 p.m.

Attest:

Cheryl A. Fernstrom, CMC, Town Clerk

Copies to: Town Council Members
Town Administrator
Town Solicitor
Finance Director

TOWN COUNCIL WORK SESSION
December 17, 2018

I. CALL TO ORDER

The Joint Jamestown Town Council and School Committee Pre-Budget Work Session was called to order at 6:02 p.m. in the Jamestown Town Hall Rosamond A. Tefft Council Chambers at 93 Narragansett Avenue by Council Vice President Meagher.

II. ROLL CALL

Town Council Members present:

Mary E. Meagher, Vice President
Nancy A. Beye
Randall White
William J. Piva, Jr.

Town Council Members absent:

Michael G. White, President

School Committee members present:

Keith J. Roberts, Chair
Sally Schott
Agnes C. Filkins
Sheila M. Reilly
Kristine A. Lapierre

Also present:

Andrew E. Nota, Town Administrator
Christina D. Collins, Finance Director
Kenneth A. Duva, School Superintendent
Jane Littlefield, Director of Finance
Erica B. Dickson, Director of Student Services
Nate Edmunds, Lawn School Principal
Carol Peterson, Melrose School Principal
Peter Anderson, Director of Facilities Maintenance
Cheryl A. Fernstrom, Town Clerk

III. JOINT TOWN COUNCIL AND SCHOOL COMMITTEE WORK SESSION
Review and Discussion of budget issues for the remainder of the current fiscal year (July 1, 2018 to June 30, 2019) and pre-budget review and discussion of issues for the next fiscal year (July 1, 2019 to June 30, 2020) pursuant to RIGL §16-2-21

Town Council and School Committee members and Administrative staffs were introduced. School Committee Chair Roberts noted this is his first joint session. Superintendent Duva

Gave an overview of the budget process and Jamestown's recognition of Melrose School as a Blue Ribbon School of excellence and the School Department's goal to continue the high level of education. Review of the RI Comprehensive Assessment System proceeded. Jamestown is rated 3rd in RI for English Language arts.

The School District uses the zero-based budgeting process based on need and is in compliance with the mandated Chart of Accounts. Discussion ensued of the process based on fluctuating populations, needs, out-of-district costs, required programs, salaries and benefits, and the goals of the strategic plan. Lengthy discussion ensued of the zero-based budgeting process.

Discussion involved the unknowns that occur, and this year a part-time nurse was hired due to an increased need. High School tuitions and the impact of the fluctuating population, including military families, were noted. Discussion involved the military families that come to Jamestown, their children who attend our schools, and that they are an asset to the community. Lengthy discussion ensued of budget development, unknown costs, and impacts.

The School Construction Program and budgeting process were reviewed. The \$5.9 million Bond Issue was approved by the voters at the November election, the budget must meet what is mandated, and they are transitioning to reflect those impending costs that will reflect an increase in the capital budget. Discussion ensued of retiring debt that will offset the increased debt for the mandated school construction project.

Town Administrator Nota commented on the open communication between Town Administration and School Department. Budget factors include revaluation which is underway, and property sales to date exceed property values, by 15% to 20%. Healthcare is usually an increase of 5%. Budget submittal is 90 days prior to the FTM, which is June 3, 2019, with departmental budget submittals by the end of December, meetings with Town Departments in January, Town Administrator's budget submission to Council in March, budget hearings in March and April, followed by budget adoption by the Council 30 days prior to the FTM.

Budget factors include debt service, healthcare and contractual obligations. Jamestown's fund balance is 20.38%, higher than most communities. Pension funding and Bond Indebtedness were reviewed. The Town's high bond rating results a lower interest rate for borrowing. The budget increase is expected at 1%. Discussion ensued of the motor vehicle tax reimbursement, at \$6,000 for Jamestown (\$500 State and \$5,500 Town).

Discussion ensued of the capital improvement budget, with reductions in recent years, and debt, which is down. The draft audit expected soon will provide more information on the general fund, reserve fund, and unreserved fund. Discussion ensued of long-term liability, including OPEB and pensions, contractual obligations and contract negotiations.

Review of Bonding ensued, including the \$5.9 million for school construction, \$2.9 million for the golf course, and \$1 million for the Library, and potential solar projects for Town and School facilities. Discussion ensued of upcoming needs for vehicle replacements and debt.

Adjournment. There being no further business to discuss, the work session was adjourned at 6:55 p.m.

Attest:

Cheryl A. Fernstrom, CMC, Town Clerk

Copies to: Town Council
 Town Administrator
 Finance Director
 Town Solicitor

**TOWN COUNCIL MEETING
December 17, 2018**

I. ROLL CALL

Town Council Members present:

Mary E. Meagher, Vice President
Nancy A. Beye
Randall White
William J. Piva, Jr.

Town Council members absent:

Michael G. White, President

Also in attendance:

Andrew E. Nota, Town Administrator
Christina D. Collins, Finance Director
Michael C. Gray, Public Works Director
Edward A. Mello, Police Chief
Andrew J. Wade, Parks and Recreation Director
Duncan Pendlebury, Ad Hoc Committee for Public Art Chair
Peter D. Ruggiero, Town Solicitor
Denise Jennings, Water and Sewer Clerk
Cheryl A. Fernstrom, Town Clerk

Vice President Meagher noted President Mike White is doing much better, as well as his wife Lee, and we wish him a speedy recovery.

II. CALL TO ORDER, PLEDGE OF ALLEGIANCE

Vice President Meagher called the regular meeting of the Jamestown Town Council to order at 7:07 p.m. in the Jamestown Town Hall Rosamond A. Tefft Council Chambers at 93 Narragansett Avenue and led the Pledge of Allegiance.

**III. TOWN COUNCIL SITTING AS THE BOARD OF
WATER AND SEWER COMMISSIONERS**

The Town Council convened as the Board of Water and Sewer Commissioners at 7:09 p.m. and adjourned as the Board of Water and Sewer Commissioners at 7:28 p.m. See Board of Water and Sewer Commissioners Minutes.

**IV. ACKNOWLEDGEMENTS, ANNOUNCEMENTS, PRESENTATIONS,
RESOLUTIONS AND PROCLAMATIONS**

None.

V. PUBLIC HEARINGS, LICENSES AND PERMITS

A) Licenses

- 1) One Day Event/Entertainment Licenses; review, discussion and/or potential action and/or vote

- 1) Applicant: Rhode Races & Events, Inc.
Event: Jamestown Rhode Race
Date: September 21, 2019
Location: Fort Getty/streets of Jamestown/Fort Getty

Karen Zyons of Rhodes Races & Events, Inc. in attendance gave a synopsis of the race and its success. Police details as required will be in place for the race.

A motion was made Councilor Piva with second by Councilor Beye to approve the One Day Event/Entertainment License for Rhode Races and Events for September 21, 2019. President White, Absent; Vice President Meagher, Aye; Councilor Beye, Aye; Councilor White, Aye; Councilor Piva, Aye.

- 2) Applicant: Conanicut Island Art Association
Event: CIAA Art Opening Receptions
Dates: February 14, March 28, May 30, September 12, and November 14, 2019
Location: Jamestown Town Hall

A motion was made by Councilor Piva with second by Councilor White to approve the Event Entertainment License for the CIAA Art Opening Receptions. President White, Absent; Vice President Meagher, Aye; Councilor Beye, Aye; Councilor White, Aye; Councilor Piva, Aye.

- 2) Bingo License Application; review, discussion and/or potential action and/or vote

- 1) Applicant: Friends of Jamestown Seniors, Inc.
Event: Bingo Games
Dates: 12-1-2018 to 11-30-2019
Location: 6 West Street
- i) RI State Police Certificate of Approval to conduct Senior Center bingo until August 31, 2019

Solicitor Ruggiero advised that as the license application period surpasses the date of expiration for the State Bingo license, the application must be modified to reflect the dates allowed by the State license.

A motion was made by Councilor Piva with second by Councilor Beye to approve the Bingo License for the Friends of Jamestown Seniors, Inc. for the period December 1, 2018 to August 31, 2019, pending the change of date on the application to the Town. President White, Absent; Vice President Meagher, Aye; Councilor Beye, Aye; Councilor White, Aye; Councilor Piva, Aye.

- 3) Holiday License Application (new); review, discussion and/or potential action and/or vote
 - 1) Young Beauty Corp. dba: Young Nails and Spa
23 Narragansett Avenue

A motion was made by Councilor Piva with second by Councilor White to approve the Holiday License for Young Beauty Corp. President White, Absent; Vice President Meagher, Aye; Councilor Beye, Aye; Councilor White, Aye; Councilor Piva, Aye.

VI. OPEN FORUM

- A) Scheduled request to address. None.
- B) Non-scheduled request to address. None.

VII. COUNCIL, ADMINISTRATOR, SOLICITOR, COMMISSION/COMMITTEE COMMENTS & REPORTS

- A) Town Administrator's Report: Andrew E. Nota

- 1) Town Council Transition and Onboarding Program

Town Administrator Nota reported On-Boarding Binders were delivered today to provide Council with a perspective from each Town department. He thanked all departments who rallied to complete the binders. As new documents and information are provided, the binders should be updated. They are also available in an electronic format. The Town Clerk will contact Councilors to schedule sessions with Town departments and determine available dates in January for a tour of Town facilities (two half-days suggested).

- 2) Rhode Island League of Cities and Towns – Energy Aggregation Program

The RI League of Cities and Towns Energy Aggregate Program (REAP) was noted and the first POWERLINE Newsletter is part of this meeting packet. The current contract with Direct Energy ends in 2019 and our electricity needs and options will be reassessed. Streetlight updates and replacement were reviewed and an RFP will be developed. Discussion continued.

- 3) Connect Greater Newport – County-wide Business Retention and Expansion Efforts

Town Administrator Nota provided updates on the initiative that includes economic development and business attraction and retention for Newport County and the Town of Bristol. Mr. Nota serves on the Steering Committee. Discussion continued.

- 4) Rhode Island League of Cities and Towns Legislative Preliminary Agenda

Town Administrator Nota reported the League is meeting to review legislative priorities for the 2019 General Assembly session as outlined in his memorandum. Upcoming editions

of The League's Newsletter will be forwarded to Council members. The Annual RI League of Cities and Towns Conference is January 24, 2019 at the Crowne Plaza in Warwick. The Conference is informative and provides networking opportunities for town councils and administration. The brochure and registration form will be forwarded to Council members.

VIII. UNFINISHED BUSINESS

- A) Review, discussion and/or potential action and/or vote regarding a Grant of Easement by and between the Town of Jamestown and the Narragansett Electric Company through a portion of Town property located on Battery Lane designated as Plat 11 Lot 11 to provide electrical service to property located on Battery Lane designated as Plat 11 Lot 38, and authorization for signing by the Town Administrator, continued from December 3, 2018

Town Administrator Nota stated the Solicitor's office has been in contact with National Grid and the Town is comfortable with the Grant of Easement to Narragansett Electric and the Building Official will perform inspections.

A motion was made by Councilor Piva with second by Councilor Beye to approve the Grant of Easement for the property located on Battery Lane, Plat 11 Lot 11, to provide electrical service to the property on Battery Lane, Plat 11 Lot 38, subject to the condition it has been inspected by the Building Official and has met his approval, and authorize signing by the Town Administrator. President White, Aye; Vice President Meagher, Aye; Councilor Beye, Aye; Councilor White, Aye; Councilor Piva, Aye.

- B) Donation of Diepenbrock Sculpture to the Town of Jamestown for placement at East Ferry, continued from September 17, 2018
- 1) Report of Jamestown Ad Hoc Committee for Public Art Chair Duncan Pendlebury
 - 2) Review, discussion and/or potential action and/or vote on the recommendations of the Jamestown Ad Hoc Committee for Public Art as outlined in their memorandum
 - a) Memorandum of Ad Hoc Committee for Public Art
 - 3) Review, discussion and/or potential action and/or vote on the recommendations of the Whale's Tail Donor Committee as outlined in their letter
 - a) Letter of Whale's Tail Donor Committee

Chair Pendlebury noted the three tasks assigned to the Ad Hoc Committee – assessment of the gift, appropriateness of the location, and developing a policy for public art and its acceptance and placement going forward. The Committee found it difficult to have definitive action without a public art policy to take into account public space, what the art program would look like, are there spaces that should be reserved, and the overall benefit to the community. The Donor Committee requested a decision by this evening's meeting and acceptance of the gift for a specified time period and location. The Ad Hoc Committee generated a memorandum outlining the motion taken as follows:

“The Ad Hoc Committee for Public Art has reviewed the donation offer for public art for the proposed whale tale sculpture dated 11/20/18 (attached) including the terms outlined in that letter. The Committee recommends that the Town Council accept the gift with no terms or strings attached, pending development of long-term specific policy with criteria for accepting public art.”

The Ad Hoc Committee feels the gift policy can be developed soon, but more time is needed, and we cannot make any recommendation as of today December 17, 2018. The Committee plans to develop a policy that addresses all issues. They appreciate the efforts of the Donor Committee and all that they have done.

Wendy Ross of East Shore, Donor Committee Member, reviewed the commitment to the project by the Donor Committee and their families. Any delay could jeopardize the donations (totaling over \$90,000) and asked the Council to approve the gift for a three to five year duration. She asked the Council to act and make their letter of today part of this meeting’s packet.

Peter Diepenbrock of Hamilton Avenue, Whale’s Tail Sculptor, stated he is not sure why the evaluation has taken so long. We made our pitch, and it is a good one. The sculpture could be a focal point for the village and we are disappointed to hear the Ad Hoc Committee is focused on policy and not on the gift.

Vice President Meagher stated it seems like a long time, but it has been four months, which is not so long in the life of a Council, especially a new Council. The Committee’s efforts and process are appreciated.

Councilor White asked if the gift is conditioned on being sited at a particular location. Wendy Ross stated yes, and the donors feel it should be a focal point located within the village. Councilor White stated he appreciates the Donor Committee’s efforts, but this is important enough that he prefers the Ad Hoc Committee come forward with a recommendation prior to accepting the gift for a particular location.

Ad Hoc Committee Chair Pendlebury noted the policy for gifting under review and their research of other art policies in order to develop one for Jamestown. Most policies have a provision that the art gift is accepted with no conditions and/or terms attached.

Peter Diepenbrock stated he doesn’t want to be characterized as impatient and noted the original proposal and timeline.

Dee Dee Sydam of Hamilton Avenue commented she doesn’t understand what the issues are with the placement of the art. This is a generous gift and she doesn’t know why there is so much over-thinking rather accepting it.

Councilor Piva stated the Council is not over thinking. Not all residents are in favor of it, and have concerns with the proposed location and that the sculpture may block the view.

The Town needs a policy in place and the gift fully vetted before moving forward with acceptance.

Vice President Meagher stated the Ad Hoc Committee was given a charge, the generosity of the gift is recognized, but more time is needed to evaluate the gift and she is inclined to grant the additional time.

Councilor Beye commented on past meeting discussions and noted other artists would like the opportunity to showcase their works as well, and in fairness to all, it is important to establish a policy as this sets a precedent.

Sav Rebecchi of Sail Street passed along his experiences on the School Committee accepting memorials for students and teachers, running out of space, and staff tasked with maintaining them. A policy is necessary and should come before acceptance.

A motion was made by Councilor Piva with second by Councilor Beye to continue this decision until the Arts Committee comes back to us with their recommendation. President White, Absent; Vice President Meagher, Aye; Councilor Beye, Aye; Councilor White, Aye; Councilor Piva, Aye.

- C) Upcoming Meetings and Sessions – dates and times
 - 1) Town Council Meeting Schedule – Monday, January 7th and Tuesday, January 22nd; review, discussion and/or potential action and/or vote
 - 2) Town Council Tour of Town Facilities; review, discussion and/or potential action and/or vote
 - 3) Interview Sessions for Town Solicitor, Probate Judge, and Board/Commission/Committee vacancies and expiring terms; review, discussion and/or potential action and/or vote

Vice President Meagher noted the January 7th and 22nd Council meetings. The Clerk will reach out to Council members for potential dates for a tour of Town facilities and individual sessions with department heads. The Town Administrator submits the budget to Council in March, and in late January scheduling of budget sessions for March and April begins. Letters of interest for Probate Judge are coming in, with a deadline of December 28th. Discussion ensued of holding interviews for Town Solicitor on January 7th, beginning at 5:30 p.m. with ½ hour for each candidate, with interviews for Probate Judge prior to the January 22nd meeting. Discussion ensued of Council meeting times, and it was the consensus to start regular Council meetings at 6:30 p.m. for consistency.

IX. NEW BUSINESS

- A) Appointment of Interim Probate Judge; (for January 2, 2019 Probate Court session); review, discussion and/or potential action and/or vote
 - 1) Ruggiero, Brochu and Petrarca

Discussion ensued of some important issues that need to be addressed.

A motion was made by Councilor Beye with second by Councilor Piva to appoint Town Solicitor Wyatt Brochu as interim Probate Judge. President White, Absent; Vice President Meagher, Aye; Councilor Beye, Aye; Councilor White, Aye; Councilor Piva, Aye.

- B) Proposed Fort Getty Fee Schedule for 2019 Season, presented by Parks and Recreation Director Andrew J. Wade; review, discussion and/or potential action and/or vote

Parks and Recreation Director Wade presented the proposed fee schedule for 2019. Seasonal reservations for the Fort Getty Campground begin in January and need to be set. Discussion ensued of the \$35,000 additional revenue that would be realized for this fiscal year with the proposed rate increases without putting too much of an increase on campers and no increase on residents.

Discussion ensued of seasonal and transient rates, rates charged in Middletown and other campgrounds, and raising rates for key summer during events such as the Folk Festival are scheduled as it is a cost-effective option for people and will increase revenues.

Director Wade noted the proposed increases would provide additional revenues in line with other campgrounds. Improvements to the Fort Getty facility were noted, including better delineation of tent campsites. With the additional amenities provided he felt it appropriate to pass on part of the costs to tent campers.

Discussion ensued of water usage at the campground, the wait list policy, transient campers, the two-week minimum reservation, occupancy rates, and long-term campers who return annually. Discussion ensued of residents who camp at Fort Getty for the season while renting out their homes.

Councilor Piva noted he likes the plan and stated we should adopt something this evening. Vice President Meagher noted the extensive use of the Fort Getty boat ramp and monitoring its use. Mr. Wade did not recommend raising rates at the boat ramp. Discussion ensued of increased use of Fort Getty and the boat ramp for kayaking, the CISF Summer Camp and other activities that place a greater demand on that facility which need review before the season begins.

Pavilion Rental revenues were reviewed. Of the 70 Pavilion rentals for the 2018 season, 48 were for residents, with one-third of them for relatives and friends of residents. If rates are increased for non-residents, they will have Jamestown residents reserve the Pavilion for them. Discussion ensued of lowering rates for Jamestown residents and other challenges. Discussion continued.

A motion was made by Councilor Piva with second by Councilor Beye to accept the proposed fee schedule for the Fort Getty Park, Campground and Pavilion as stated

in Andy Wade's memo. President White, Absent; Vice President Meagher, Aye; Councilor Beye, Aye; Councilor White, Aye; Councilor Piva, Aye.

- C) Award of Bid: Floating Dock and Pile Replacement Project at East Ferry to Regan Construction Corporation for an amount not to exceed \$80,000.00, as recommended by Public Works Director Michael C. Gray; review, discussion and/or potential action and/or vote

The drawing related to the bid was noted. Public Works Director Gray commented on the October 2017 storm that caused extensive damage to the East Ferry dock. Bids came in slightly higher than the amount received from the insurance company and alternatives were developed to keep costs down, provide more room to navigate, and authorized by our insurance carrier. The base bid is to replace the piles and float.

A motion was made by Councilor White with second by Councilor Piva to approve the award of bid for the floating dock and pile replacement project at East Ferry to Regan Construction Company as described. President White, Absent; Vice President Meagher, Aye; Councilor Beye, Aye; Councilor White, Aye; Councilor Piva, Aye.

X. ORDINANCES, APPOINTMENTS, VACANCIES AND EXPIRING TERMS

- A) Appointments, Vacancies, and Expiring Terms; review, discussion and/or potential action and/or vote
 - 1) Jamestown Affordable Housing Committee (Three vacancies with One vacancy with a three-year term ending date of May 31, 2021, One vacancy with an unexpired three-year term ending date of May 31, 2020 and One vacancy with an unexpired three-year term ending date of May 31, 2019); duly advertised
 - a) Letters of resignation
 - i) Edie Flynn
 - ii) Lydia Thomas
 - iii) William J. Piva, Jr.
 - b) Letters of interest for appointment
 - i) Sydney Keen – for full term
 - ii) Fred Pease – for unexpired term

A motion was made by Councilor Piva with second by Councilor Beye to appoint Fred Pease to the Affordable Housing Committee. President White, Absent; Vice President Meagher, Aye; Councilor Beye, Aye; Councilor White, Aye; Councilor Piva, Aye.

- 2) Jamestown Conservation Commission (Two vacancies with three-year term ending dates of December 31, 2021); duly advertised
 - a) Letter of resignation
 - i) Bill Reardon
 - b) Letter of interest for reappointment
 - i) Phil Larson

- c) Letters of interest for appointment
 - i) Jessica Wurzbacher
 - ii) Sydney Keen
 - iii) Susan Gorelick
- 3) Jamestown Fire Department Compensation Committee (One vacancy with a three-year term ending date of May 31, 2021); duly advertised
 - a) Letter of resignation
 - i) Jerome Scott
 - b) Letter of interest for appointment
 - i) Sydney Keen
- 4) Jamestown Harbor Management Commission (Three vacancies with three-year term ending dates of December 31, 2021); duly advertised
 - a) Letters of interest for reappointment
 - i) Eric Lexow
 - ii) Wayne Banks
 - iii) Daniel Wurzbacher
 - b) Letters of interest for appointment
 - i) John Primiano
 - ii) Nicholas Radesca
 - iii) Stephen Murphy

Sydney Keen should be interviewed, as she has applied for several positions. Discussion ensued of interviewing current members as well as new applicants, effectiveness of current members, and their attendance records. Appointments will be continued.

- 5) Jamestown Juvenile Hearing Board – Member (Two vacancies with three-year term ending dates of December 21, 2021); duly advertised
 - a) Letter of resignation
 - i) Richard Mulcahey
 - b) Letter of interest for reappointment
 - i) Barbara Szepatowski
 - c) Letter of interest for appointment to full Member from Alternate Member position
 - i) Michael Lichtenstein
- 6) Jamestown Juvenile Hearing Board (Two Alternate Member vacancies with two-year term ending dates of December 31, 2020); duly advertised
 - a) Letter of resignation
 - i) Cheryl Petrosinelli
 - b) Letter of interest for appointment
 - i) Sydney Keen

Michael Lichtenstein has served the Board well, should be appointed as a full Member, and hold any appointment of an Alternate.

A motion was made by Councilor Piva with second by Councilor White to appoint Michael Lichtenstein to the full appointment. President White, Absent; Vice President Meagher, Aye; Councilor Beye, Aye; Councilor White, Aye; Councilor Piva, Aye.

A motion was made by Councilor Piva with second by Councilor Beye to reappoint Barbara Szepatowski to the position of Member of the Juvenile Hearing Board. President White, Absent; Vice President Meagher, Aye; Councilor Beye, Aye; Councilor White, Aye; Councilor Piva, Aye.

- 7) Jamestown Philomenian Library Board of Trustees (Two vacancies with three-year term ending dates of December 31, 2021); duly advertised
 - a) Letters of resignation
 - i) Marianne Kirby
 - ii) Mary Lou Sanborn
 - b) Letter of interest for appointment
 - i) Eugene Mihaly

Marianne Kirby and Mary Lou Sanborn have resigned. Gene Mihaly, who previously served as Chair of the Library Trustees, has applied for appointment and has extensive experience in fund raising. We will need to advertise for one vacancy.

A motion was made by Councilor White with second by Councilor Piva to appoint Gene Mihaly to the Library Board. President White, Absent; Vice President Meagher, Aye; Councilor Beye, Aye; Councilor White, Aye; Councilor Piva, Aye.

- 8) Jamestown Planning Commission (One vacancy with a four-year term ending date of December 31, 2022); duly advertised
 - a) Letter of interest for reappointment
 - i) Dana Prestigiaco
 - b) Letters of interest for appointment
 - i) Richard Lynn
 - ii) Sydney Keen
 - iii) Eric Brine
- 9) Jamestown Traffic Committee – Member-at-Large (Two vacancies with three-year term ending dates of December 31, 2021); duly advertised
 - a) Letter of resignation
 - i) Melissa Mastrostefano
 - b) Letter of interest for reappointment
 - i) Vincent Moretti
 - c) Letter of interest for appointment
 - i) Valerie Southern

The Planning Commission appointment should be continued. The Traffic Committee has two vacancies and two applicants.

A motion was made by Councilor Piva with second by Councilor White to reappoint Vincent Moretti to the Traffic Committee. President White, Absent; Vice President Meagher, Aye; Councilor Beye, Aye; Councilor White, Aye; Councilor Piva, Aye.

A motion was made by Councilor Piva with second by Councilor White to appoint Valerie Southern to the Traffic Committee. President White, Absent; Vice President Meagher, Aye; Councilor Beye, Aye; Councilor White, Aye; Councilor Piva, Aye.

- 10) Jamestown Tree Preservation and Protection Committee (Four vacancies with One unexpired three-year term ending date of December 31, 2019 and Three three-year term ending dates of December 31, 2021); duly advertised
 - a) Letter of resignation (unexpired term)
 - i) Richard Lynn
 - b) Letters of resignation (full terms)
 - i) Peter Kallman
 - ii) Mark Girard
 - c) Letter of interest for reappointment
 - i) Elaine Peterson

There are four vacancies, with three resignations and a letter requesting reappointment by Elaine Peterson, who has done a great job. Advertising the vacancies should continue.

A motion was made by Councilor Piva with second by Councilor Beye to reappoint Elaine Peterson. President White, Absent; Vice President Meagher, Aye; Councilor Beye, Aye; Councilor White, Aye; Councilor Piva, Aye.

- 11) Jamestown Zoning Board of Review – Member (One vacancy with a five-year term ending date of December 31, 2023); duly advertised
 - a) Term limit reached
 - i) Richard Boren
 - b) Letter of interest to be reappointed and to serve as full Member from Alternate Member
 - i) Lisa Hough – 2nd Alternate
- 12) Jamestown Zoning Board of Review – Alternate Member (Three vacancies with one-year term ending dates of December 31, 2019); duly advertised
 - a) Letter of interest to remain as Alternate Member
 - i) Judy Bell – 1st Alternate
 - b) Letter of interest for appointment
 - i) Erik Brine

Discussion ensued of the expiring term of Richard Boren and term limits. There has been discussion of reappointment of Richard Boren, based on the Charter provision allowing a member with special skills to be reappointed. Members serve until they are replaced or

discharged. The Charter provision adopted in 2016 has never been used. Mr. Boren has not reapplied for the position, referencing the Charter provision, and this should be continued. As more information is needed.

XI. CONSENT AGENDA

A motion was made by Councilor Piva with second by Councilor Beye to approve and accept the Consent Agenda. President White, Absent; Vice President Meagher, Aye; Councilor Beye, Aye; Councilor White, Aye; Councilor Piva, Aye.

The Consent Agenda approved consists for the following:

- A) Adoption of Town Council Minutes
 - 1) December 3, 2018 (regular meeting)
- B) Minutes of Town Boards/Commissions/Committees
 - 1) Harbor Commission (11-14-2018)
- C) CRMC Notices
 - 1) December 2018 Calendar
- D) One Day Event/Entertainment License Application
 - 1) Applicant: Jamestown Community Band
 - Event: Annual Holiday Concert
 - Date: December 18, 2018
 - Location: Recreation Center
- E) Finance Director's Report

XII. COMMUNICATIONS, PETITIONS, AND PROCLAMATIONS AND RESOLUTIONS FROM OTHER RHODE ISLAND CITIES AND TOWNS

A motion was made by Councilor Piva with second by Councilor Beye to receive the Communications. President White, Absent; Vice President Meagher, Aye; Councilor Beye, Aye; Councilor White, Aye; Councilor Piva, Aye.

The Communications, Petitions, and Resolutions and Proclamations from other RI cities and towns received consists of the following:

- A) Communications
 - 1) Letter of Friends of Jamestown Rights-of-Way requesting the Town Council rescind the vote to relinquish its rights to the paper street known as Bell Lane
 - 2) Letter of Jamestown Philomenian Library Board of Trustees requesting to participate in the reviewing, vetting, and interviewing of applicants for the Library Board of Trustees
 - 3) Statewide Planning December 2018 Newsletter

XIII. AGENDA ITEMS FOR THE NEXT MEETING AND FUTURE MEETINGS

- A) Veterans' Exemptions (January 22)
- B) Beavertail Lighthouse Property "Excess" Classification and future State and local interest (January)
- C) Water Resources Protection Committee (January)
- D) Conanicut Island Sanctuary Trail proposed parking area (January)
- E) Authorization to proceed to 100% design and bid document development for Golf Course Clubhouse project (January)
- F) Parking at Mackerel Cove (January 7)
- G) Proposed Department of Seniors (January 22)
- H) Budget Work Sessions for FY 2019-2020
- I) Future Improvements to East Ferry boat ramp
- J) Paper streets in Jamestown and water access

Discussion involved the following:

- Rules and Procedures for the January 22nd agenda
- Council Liaison positions for the January 7th agenda
- Goals and Objectives for the January 22nd agenda

XIV. EXECUTIVE SESSION

- A) Pursuant to RIGL § 42-46-5(a) Subsection (1) Personnel (employment status, settlement approval, and authorization to sign agreement by Town Administrator Nota); review, discussion and/or potential action and/or vote in executive session and/or open session
- B) Pursuant to § RIGL 42-46-5(a) Subsection (2) Collective Bargaining (NAGE 68 and NAGE 69 announcement of union contract negotiations); review, discussion and/or potential action and/or vote in executive session and/or open session

A motion made by Councilor Piva with second by Councilor White to enter into Executive Session at 9:02 p.m. pursuant to RIGL § 42-46-5(a) Subsection (1) and RIGL § 42-46-5(a) Subsection (2) to discuss Personnel and Collective Bargaining.

Pursuant to RIGL § 42-46-5(a) Subsection (1) and RIGL § 42-46-5(a) Subsection (2) the following vote was taken to discuss Personnel and Collective Bargaining: President White, Absent; Vice President Meagher, Aye; Councilor Beye, Aye; Councilor White, Aye; Councilor Piva, Aye.

The Town Council reconvened the regular meeting at 9:19 p.m. Vice President Meagher announced that the Town Council voted in Executive Session to approve the personnel settlement agreement upon final review and approval of the agreement language by Town Solicitor Ruggiero and authorize signing by Town Administrator Nota.

A motion was made by Councilor Beye with second by Councilor Piva to seal the

Minutes of the Executive Session. President White, Absent; Vice President Meagher, Aye; Councilor Beye, Aye; Councilor White, Aye; Councilor Piva, Aye.

XV. ADJOURNMENT

A motion was made by Councilor Piva with second by Councilor Beye to adjourn. President White, Absent; Vice President Meagher, Aye; Councilor Beye, Aye; Councilor White, Aye; Councilor Piva, Aye.

The Jamestown Town Council adjourned the regular meeting at 9:20 p.m.

Attest:

Cheryl A. Fernstrom, CMC, Town Clerk

Copies to: Town Council
 Town Administrator
 Finance Director
 Town Solicitor

MEETING MINUTES
JAMESTOWN PHILOMENIAN LIBRARY
Library Renovation Building Committee
November 8, 2018

I. Call to order: Roll Call: Building Committee chair, Paul Housberg, called the meeting to order at 5:05PM. In attendance: Lisa Bryer, Jack Evans, Mohamad Farzan, Bob Flath, Donna Fogarty, Paul Housberg, Mary Lou Sanborn: guests – Dan Danisi (Creative Environment), Steve Otten (Structural Engineer)

II. Approval of October 2, 2018 Meeting Minutes: A motion was made by Lisa Bryer, seconded by Bob Flath to approve the October 2nd Meeting Minute as presented. The motion passed unanimously.

III. Review/update on preliminary schematic design and associated costs and design development documents: Mohamad Farzan introduced Dan Danisi from Creative Environment and Steve Otten , structural engineer who are working on the building renovation plans. Mohamad indicated the team was ahead of schedule in the document phase. Jack Evans reviewed each page of the drawings noting the following revisions:

- page SP2 – enlarged solar array per Newport Solar
- page D1.0 – no changes
- EX1.0 – no changes
- EX1.1 – no changes, existing conditions
- EX1.2 – no changes, existing conditions
- A1.0 - no changes, includes compact shelving as a “holder” and elevator: it was suggested to Have partition include the oil tanks
- A1.1 – revisions include one central librarian desk between Childrens” and Young Adult areas, moved glass enclosed reading space to east side – suggestion to change to pocket doors to allow for more open area atmosphere, relocated information desk (AKA circulation desk) to area near east side entrance door with pocket doors to allow for flexibility. Glass partition opposite information desk to allow for lighting but quiet space. #125 – change to small meeting room, outside of east side entrance to include protective bar to driveway, #119 – change of office location, #118 – change of storage in flex space, #115 – to include sink and cabinets with locked door system, #104 – adult use computers and reference desk – both of these may be relocated
- A6.1 - reflective ceiling panels
- A9.1 - tiered shelving by area (ie – adult taller shelving than childrens’ area)

Mohamad and Jack to meet with Donna and library staff for further interior re-design. Discussion took place regarding the details of the HVAC system.

IV. Schedule future meetings: The next meeting of the Building Committee will take place on Tuesday, December 4th at 5:00PM

V. Public Comment: None

VI. Adjournment: A motion was made by Bob Flath, seconded by Lisa Bryer to adjourn the meeting at 6:25PM. The motion passed unanimously.

Respectfully submitted,
Mary Lou Sanborn

JAMESTOWN PHILOMENIAN LIBRARY
26 North Main Road, Jamestown, RI 02835
Board of Trustees Meeting Minutes
Tuesday, November 13, 2018

Residents of Jamestown and visitors to the library are informed, connected to the community, culturally enriched, and supported as life-long learners in a safe and welcoming environment.

A. Call to Order:

The meeting was called to order at 5:00 pm by board chair Sanborn. In attendance were Jennifer Cloud, Lisa Sheley, Peter Carson, Paul Housberg, Mary Lou Sanborn, Christian Infantalino and Marianne Kirby. Chris Walsh arrived 6:09.

B. Executive Session - The Library Board of Trustees may seek to go into Executive Session to discuss the following item:

1 Pursuant to RIGL §42-46-5(a) Subsection (10) - Any discussion of the personal finances of a prospective donor to a library.

A motion by Carson to move into executive session at 5:02; seconded by Housberg. Motion passed unanimously.

A motion by Kirby to move out executive session at 5:57; seconded by Infantolino. Motion passed unanimously.

C. Consent Agenda: An item on the Consent Agenda need not be removed for simple clarification or correction of typographical errors. Approval of the Consent Agenda shall be equivalent to approval of each item as if it had been acted upon separately.

1. Minutes from October 9, 2018 LBOT Monthly Meeting Minutes
2. Financial Reports:
 - a. Library
 - b. Trustee
3. Progress and service report of the Library Director

A motion was made by Carson to approve consent agenda, Cloud seconded . The motion passed unanimously.

D. Friends of Library Report: Board chair Sanborn attended meeting. Discussion was for December programming and museum passes.

E. Unfinished Business:

1. Board of Trustees sub-committees update:

a. Finance/Budget:

Board member Carson is looking into Rhode Island Foundation endowment and capital account fund as source of money for building renovation expenses. The capital account the town maintains is dwindling and JPL Foundation will need to transfer funds.

b. Policy:

Discussion took place regarding the language in Policies B1, B2, B3. Voted to accept language stem "shall not fail to..." passes with 4 approvals. Cloud abstained, Carson and Sanborn opposed; Walsh, Kirby, Housberg and Infantolino approved.

Motion made by Infantolino to add the word "industry" to B1 and approve policy, Cloud seconded. Motion passed unanimously.

Motion made by Infantolino to approve Policy B2 seconded by Housberg. Carson abstained, Sanborn opposed, Cloud, Kirby, Walsh, Infantolino and Housberg approved.

Motion made by Infantolino to approve Policy B3 seconded by Walsh. Carson abstained, Sanborn opposed, Cloud, Kirby, Walsh, Infantolino and Housberg approved.

Board members asked to review policies B4, B5, B6, and B7 for December meeting.

c. Facilities: Second quote for fall cleanup is coming in soon.

2. Library Renovation Project:

- a. Building Committee: Housberg took board members through current building revisions. Next meeting is scheduled for December 4, 5:00 p.m.
- b. Fundraising: Discussion around advertisement to be placed in Jamestown Press to thank Jamestown voters for bond approval. Kirby made a motion to place advertisement in Jamestown Press, seconded by Infantolino. Motion passed unanimously. It was suggested to include same ad info on library web site. It was also suggested to advertise "Giving Day" on the library web site.
- c. Project Outline: Sanborn will attend Town Council December 5th meeting to congratulate Town Council members on their recent election and to tour facilities and review building renovation plans.

3. Board Process Review: Everyone's okay.

4. Playground Renovation Committee: Letter to Recreation Department to work

together to facilitate increased activity due to playground opening.

5. Jamestown Philomenian Library Foundation: New board member, Ben Thomas approved and joining in December.
6. November Library Bond Referendum: Completed. Remove item from agenda.
7. Letter to Town Council Regarding LBOT vacancies: Letter for review December meeting.

F. New Business:

1. JPL debit/credit card: postponed – discussion postponed until December meeting
2. LBOT executive board appointments in January. Chris Walsh to coordinate.
3. 2019 state grant in Aid/Operating Budget. OLIS has reduced 2018-2019 State Grant Aid due to reporting error in 2016 and 2017.

G. Future Agenda Items: None

H. Public Comment: None

I. Adjournment

A motion was made by Carson, seconded by Kirby to adjourn the meeting at 7:32 p.m. The motion passed unanimously.

Date of next meeting: Tuesday, December 11, 2018.

Respectfully submitted,
Marianne Kirby
Secretary

JAMESTOWN TRAFFIC COMMITTEE

Meeting Minutes

Thursday, November 15, 2018

Approved: 12/20/2018

I. A regular meeting of the Jamestown Traffic Committee was called to order at the Jamestown Town Hall, Conference Room, 93 Narragansett Avenue at 6:00 PM by Chairman Tighe.

II. The following members were present:

Thomas Tighe, Chairman
Mary Meagher, Vice-Chairman
William Munger
Timothy Yentsch
Vincent Moretti

The following members were absent:

David Cain

Also present:

Kim Devlin, Clerk

III. READING AND APPROVAL OF MIUNTES

A) September 20, 2018 (regular meeting)

Member Munger moved to approve the minutes; Member Moretti seconded. So voted; 5 ayes, 0 nays.

IV. OPEN FORUM

A) Scheduled Requests to Address

There were no Scheduled Requests to Address.

B) Non-Scheduled Requests to Address

Mr. Sav Rebecchi, 19 Sail Street, requested that the Traffic Commission allow him to speak on agenda item 5(C) at this time.

Vice-Chairman Meagher moved to move up item 5(C); Member Munger seconded. So voted; 5 ayes, 0 nays.

VI. NEW BUSINESS

C) Parking restrictions in the Shores; review and discussion and/or potential action and/or vote

Mr. Rebecchi stated that a few years back there were parking restrictions set in the south shores, with the intent to set similar restrictions in the entire shores neighborhood. The residents of the shores strongly opposed the restrictions and the Traffic Committee and Town Council decided to forgo the restrictions outside of the south shores, where the restrictions were already in place.

Mr. Rebecchi handed out a printout of a street sign of the restrictions and a map pf the area where the restrictions are in place.

Vice-Chairman Meagher stated that on Hull Street there were major parking issues with fishermen parking overnight that was driving the discussion of instituting parking restrictions. After the ordinance was put into place it helped with the parking issues, but maybe there is a way to shrink down the parking restrictions to include only the problem areas.

Mr. Rebecchi stated that his objection is, is that the restrictions only apply to the south shores and it seems like this area of the shores is being singled out.

Member Munger stated that the intent was not to single out an area but to offer relief where there were parking issues.

Member Yentsch stated that he was receiving complaints from people in the Shores Association about parking issues near the water. After the restrictions were put into place the parking problems were solved.

Chairman Tighe stated that the item will be placed on the December Traffic Committee agenda and Police Chief Mello will be consulted on the matter.

Vice-Chairman Meagher stated that the item should be sent to the Town Council with more detail included and it should be discussed at a Public Hearing.

Chairman Tighe moved to move up item 5(A); Vice-Chairman Meagher seconded. So voted; 5 ayes, 0 nays.

A) Revision of the Jamestown Code of Ordinances Chapter 70 Traffic and Vehicles, Article IV. Stopping, Standing and Parking, Sec 70-87 Prohibited or restricted parking on specified streets, *Melrose Avenue*, from: "no parking on the east side from the intersection of Watson Avenue north to the intersection of West Passage Drive" to "no parking on the west side from the intersection of Watson Avenue north to the intersection of West Passage Drive" as requested by John Civic; review and discussion and/or potential action and/or vote

Dr. John Civic addressed the Traffic Committee regarding parking issues on Melrose Avenue. Dr. Civic stated that the problem is drainage from Melrose running off through his property. Dr. Civic stated that parents dropping and picking up children from Melrose school for years have parked on his lawn, which has created ruts where the grass won't grow. This has caused the runoff from Melrose Avenue to flow into his courtyard which has resulted in the courtyard becoming impervious.

Dr. Civic stated that, in order to mitigate this problem, he has replanted the areas that have been rutted out over the years and has also placed timber beams along the edge of his property to prevent vehicles from parking on the grass.

Dr. Civic stated that there is only one way to get to Melrose School and there is no parking on the east side of the road, so drivers park their cars on the west side of the road facing the wrong direction. This means that they are dropping their children off across the street from the school and the passenger side doors are on the traffic side of the street.

Vice-Chairman Meagher stated that it seems that it would be better if parking were allowed on the east side and prohibited on the west side of Melrose Avenue. This would make the traffic flow much easier and also mitigate the runoff problem.

Chairman Tighe stated that we will forward this to Police Chief Mello to look at the history and to talk to the school officials. We will get their opinions and add this item to the next agenda.

D) Review of Parking and Traffic issues in the area of North Road and Watson Avenue related to the Village Hearth Bakery, as requested by the Town Council; review and discussion and/or potential action and/or vote

- 1) Email of Ty Sutton regarding parking issues related to the Village Hearth Bakery
- 2) Letter of Andrea Colognese in response to an email of Ty Sutton regarding parking issues related to the Village Hearth Bakery

Chairman Tighe stated that Mr. Sutton has requested a continuance and the Village Hearth Bakery owners have been notified that the item is continued until the December meeting.

B) Vegetation height at street corners in Jamestown; review and discussion and/or potential action and/or vote

Chairman Tighe stated that Chris Costa is sending Mr. Sutton a violation of the Zoning Ordinance for having overgrown hedges.

Member Moretti stated that this is a problem all over the island.

Chairman Tighe stated that this item will not be on the agenda again.

V. UNFINISHED BUSINESS

A) Increasing the speed limit on North Road; review and discussion and/or potential action and/or vote (Continued from 5/17/2018)

Chairman Tighe stated that we need to wait until the North Road project is complete but we want to keep this on the agenda.

B) Update on crosswalk at Watson Avenue and North Road; obstructed view caused by hedges; review and discussion and/or potential action and/or vote (continued from 9/20/2018)

Chairman Tighe stated that this item was discussed already.

C) Alternative location for crosswalk on Conanicus Avenue; review and discussion and/or potential action and/or vote (continued from 9/20/2018)

- 1) Letter of State Traffic Commission to Police Chief Mello
- 2) Report of Crossman Engineering to State Traffic Commission
- 3) Letter of request to State Traffic Commission by Police Chief Mello
- 4) Diagram of proposed crosswalk

Member Munger stated that it is great that we have a response but that he is disappointed at the result.

Member Munger moved to drop the item from the agenda, Member Moretti seconded. So voted; 5 ayes, 0 nays.

VI. NEW BUSINESS

E) Agenda items for the next and/or future agendas; review, discussion and/or potential action and/or vote

Chairman Tighe stated that New Business items A, C and D will be continued until the next meeting.

F) Upcoming meeting schedule; review, discussion and/or potential action and/or vote

The next meeting will be held on December 20th.

VIII. ADJOURNMENT

There being no further business before the Committee, a motion was made by Vice-Chairman Meagher and seconded by Member Yentsch to adjourn the meeting at 6:50 PM. So unanimously voted.

Attest:

Kim Devlin
Clerk

JAMESTOWN ZONING BOARD OF REVIEW

Minutes of the November 27, 2018 Meeting

A regular meeting of the Jamestown Zoning Board of Review was held at the Jamestown Town Hall, 93 Narragansett Avenue. The Chairman called the meeting to order at 7:00 p.m. The clerk called the roll and noted the following members present:

Richard Boren, Chair
Terence Livingston, Member
Edward Gromada, Member
Marcy Coleman, Member
Judith Bell, 1st Alt.
Lisa Hough, 2nd Alt.

Also present: Brenda Hanna, Stenographer
Chris Costa, Zoning Officer
Pat Westall, Zoning Clerk
Wyatt Brochu, Counsel

MINUTES

Minutes of October 23, 2018

A motion was made by Edward Gromada and seconded by Terence Livingston to accept the minutes of the October 23, 2018 meeting as presented.

The motion carried by a vote of 5 -0.

Richard Boren, Terence Livingston, Edward Gromada, Marcy Coleman, and Judith Bell voted in favor of the motion.

Lisa Hough was not seated and Dean Wagner was absent.

CORRESPONDENCE

A request for a one year extension of a previously granted variance from William & Cinthia Reppe for Plat 1, Lot 39.

Reppe

A motion was made by Terence Livingston and seconded by Marcy Coleman to grant a one year extension, January 23, 2019, to William & Cinthia Reppe of a previously granted variance for Plat 1, Lot 39.

The motion carried by a vote of 5 -0.

Richard Boren, Terence Livingston, Edward Gromada, Marcy Coleman, and Judith Bell voted in favor of the motion.

Lisa Hough was not seated and Dean Wagner was absent.

A letter From Deborah Foppert, attorney for the applicant, Wildacre Allagash, LLC, to withdraw the variance & special use request without prejudice of Wildacre Allagash, LLC for Plat 15, Lot 215.

Wildacre

A motion was made by Edward Gromada and seconded by Terence Livingston to grant the request to withdraw the variance & special use request without prejudice of Wildacre Allagash, LLC for Plat 15, Lot 215.

The motion carried by a vote of 5 -0.

Richard Boren, Terence Livingston, Edward Gromada, Marcy Coleman, and Judith Bell voted in favor of the motion.

Lisa Hough was not seated and Dean Wagner was absent.

OLD BUSINESS

Wurman

A motion was made by Judith Bell and seconded by Terence Livingston to grant the request of Vanessa Wurman, whose property is located at 450 E. Shore Rd., and further identified as Assessor's Plat 4, Lot 15 for a variance from Article 3, Section 302, Dimensional Regulations Article 6, Section 82-606 to raise the roof line on the existing garage with crawl space to accommodate for a guest room which exceeds the granted 19' as determined by previously submitted plans.

This Board has determined that this application does satisfy the requirements of ARTICLE 6, SECTION 600, SECTION 606, and SECTION 607, PARAGRAPH 2.

This Variance is granted with the following restriction/condition(s):

This project must be constructed in strict accordance with the site and building plans duly approved by this Board.

This motion is based on the following findings of fact:

1. Said property is located in a RR80 zone and contains 1.74 acres.
2. Restrictions on short term rentals of the additional space will apply. Re: Less than 30 days.

The motion carried by a vote of 5 -0.

Richard Boren, Terence Livingston, Edward Gromada, Judith Bell and Lisa Hough voted in favor of the motion.

Marcy Coleman was not seated and Dean Wagner was absent.

Lisa Hough left after this application.

NEW BUSINESS

Angel's Kitchen

A motion was made by Marcy Coleman and seconded by Terence Livingston to grant the request of Angels Kitchen, whose property is located at 23 Narragansett Ave., and further identified as Assessor's Plat 9, Lot 568 for a special use permit from Article 6, Section 82-601, Special Use Permits authorized by this ordinance, Article 3, Table 3.1 Restaurant with Alcohol, to serve beer & wine.

This Board has determined that this application does satisfy the requirements of ARTICLE 6, SECTIONS 600 and 602.

This motion is based on the following findings of fact:

1. Angel's Kitchen is the DBA for Johnny Angel's Clam shack, LLC.

2. Said property is located in a CL zone. Zoning requires granting of a special use permit to serve wine and beer.
3. The restaurant has been opened for approximately 6 weeks.
4. The applicant is seeking to serve beer and wine for customers to enjoy with their meals.
5. The area of service and consumption will be limited to the interior space of the restaurant.
6. Granting of the special use permit will not result in conditions inimical to the public health, safety, morals and welfare.
7. The granting of the special use permit will not substantially or permanently injure the appropriate use of the property in the surrounding area or district.

The motion carried by a vote of 5 -0.

Richard Boren, Terence Livingston, Edward Gromada, Marcy Coleman, and Judith Bell voted in favor of the motion.

Lisa Hough and Dean Wagner were absent.

Barber

A motion was made by Marcy Coleman and seconded by Terence Livingston to continue the request of Donata & Neill Barber, whose property is located at 108 Howland Ave., and further identified as Assessor's Plat 9, Lot 516 for a variance & special use permit to the December 18, 2018 meeting.

The motion carried by a vote of 5 -0.

Richard Boren, Terence Livingston, Edward Gromada, Marcy Coleman, and Judith Bell voted in favor of the motion.

Lisa Hough and Dean Wagner were absent.

Jamestown Beer

A motion was made by Terence Livingston and seconded by Edward Gromada to grant the request of Jamestown Beer Holdings LLC (Okema Prop. LLL, owner) whose property is located at 34 Narragansett Ave., and further identified as Assessor's Plat 8, Lot 453 for a special use permit from Article 3, Section 82-301, Table 3-1 VIB Tavern/Bar, Article 6, Section 82-601 special use permit to operate a nanobrewery and taproom.

This Board has determined that this application does satisfy the requirements of ARTICLE 6, SECTIONS 600 and 602.

This Special Use Permit is granted with the following restriction/condition(s):

1. That the alcohol consumption will be interior only.
2. The applicant shall use advanced technology to minimize water use.

This motion is based on the following findings of fact:

1. Said property is located in a CD zone and contains 1,373 sq. ft.
2. The applicant shall use advanced technology to minimize water use.
3. The alcohol consumption will be interior only.
4. The nano-brewery economic vitality to the village district.
5. There is ample parking for the establishment.

The motion carried by a vote of 5 -0.

Richard Boren, Terence Livingston, Edward Gromada, Marcy Coleman, and Judith Bell voted in favor of the motion.

Lisa Hough and Dean Wagner were absent.

Young Appeal

A motion was made by Richard Boren and seconded by Terence Livingston to continue the appeal of Paul Hamilton and Patricia Young whose property is located at 260 Beavertail Road, Jamestown, RI, and further identified as Tax Assessor's Plat 12, Lots 42 and 212, to the Dec. 18, 2018 meeting.

The motion carried by a vote of 5 -0.

Richard Boren, Terence Livingston, Edward Gromada, Marcy Coleman, and Judith Bell voted in favor of the motion.

Lisa Hough and Dean Wagner were absent.

ADJOURNMENT

A motion was made and seconded to adjourn at 8:15 p.m.
The motion carried unanimously.

The meeting reconvened and a date of Dec. 14, 2018 was set for the
briefs to be submitted by 12:00 pm.

A motion was made and seconded to adjourn at 8:20 p.m.
The motion carried unanimously.



State of Rhode Island and Providence Plantations
Coastal Resources Management Council
Oliver H. Stedman Government Center
4808 Tower Hill Road, Suite 116
Wakefield, RI 02879-1900

(401) 783-3370
Fax (401) 783-3767

JANUARY 2019 CALENDAR

- Thursday, January 3** **CRMC Fishermen's Advisory Board Meeting.** URI Coastal Institute - Hazards Room; 215 South Ferry Rd, Narragansett, RI.
5:00 p.m.
- Tuesday, January 8** **Policy & Planning Subcommittee Meeting.** Cervenka Green Ducharme Antonelli, LLC; 235 Promenade Street, Suite 475; Providence, RI.
4:00 p.m.
- Tuesday, January 8** **Semimonthly Meeting.** Administration Building, Conference Rm A, One Capitol Hill, Providence, RI.
6:00 p.m.
- Tuesday, January 15** **CRMC Fishermen's Advisory Board Meeting.** URI Coastal Institute - Large Conference Room; 215 South Ferry Rd, Narragansett, RI.
5:00 p.m.
- Tuesday, January 22** **ROW Subcommittee Meeting.** Administration Building, Conference Room A, One Capitol Hill, Providence, RI.
5:45 p.m.
- Tuesday, January 22** **Semimonthly Meeting.** Administration Bldg, Conference Rm A, One Capitol Hill, Providence, RI.
6:00 p.m.
- Friday, January 25** **Administrative Fine Hearings.** CRMC Conference Room, Oliver Stedman Government Center, 4808 Tower Hill Road, Wakefield, RI.
9:30 a.m.

Individuals requesting interpreter services for the hearing impaired for any of the above meetings must notify the Council office at (783-3370) 72-hours in advance of the meeting date.



State of Rhode Island and Providence Plantations
Coastal Resources Management Council
 Oliver H. Stedman Government Center
 4808 Tower Hill Road, Suite 3
 Wakefield, RI 02879-1900

(401) 783-3370
 Fax (401) 783-2069

PUBLIC NOTICE

File Number: 2018-12-024 Date: January 2, 2019

This office has under consideration the application of:

Antony J. Abbiati & Alicia J. Collins
38 Collins Terrace
Jamestown, RI 02835

for a State of Rhode Island Assent to construct and maintain:

a residential boating facility over eelgrass with a 1200lb tender lift extending 161' beyond mean low water (MLW) to a water depth of -5' MLW.

Project Location:	38 Collins Terrace
City/Town:	Jamestown
Plat/Lot:	2 / 95
Waterway:	East Passage of Narragansett Bay

Plans of the proposed work may be seen at the CRMC office in Wakefield.

In accordance with the Administrative Procedures Act (Chapter 42-35 of the Rhode Island General Laws) you may request a hearing on this matter.

You are advised that if you have good reason to enter protests against the proposed work it is your privilege to do so. It is expected that objectors will review the application and plans thoroughly, visit site of proposed work if necessary, to familiarize themselves with the conditions and cite what law or laws, if any, would in their opinion be violated by the work proposed.

If you desire to protest, you must attend the scheduled hearing and give sworn testimony. A notice of the time and place of such hearing will be furnished you as soon as possible after receipt of your request for hearing. If you desire to request a hearing, to receive consideration, it should be in writing (**with your correct mailing address, e-mail address and valid contact number**) and be received at this office on or before February 2, 2019.

/lat

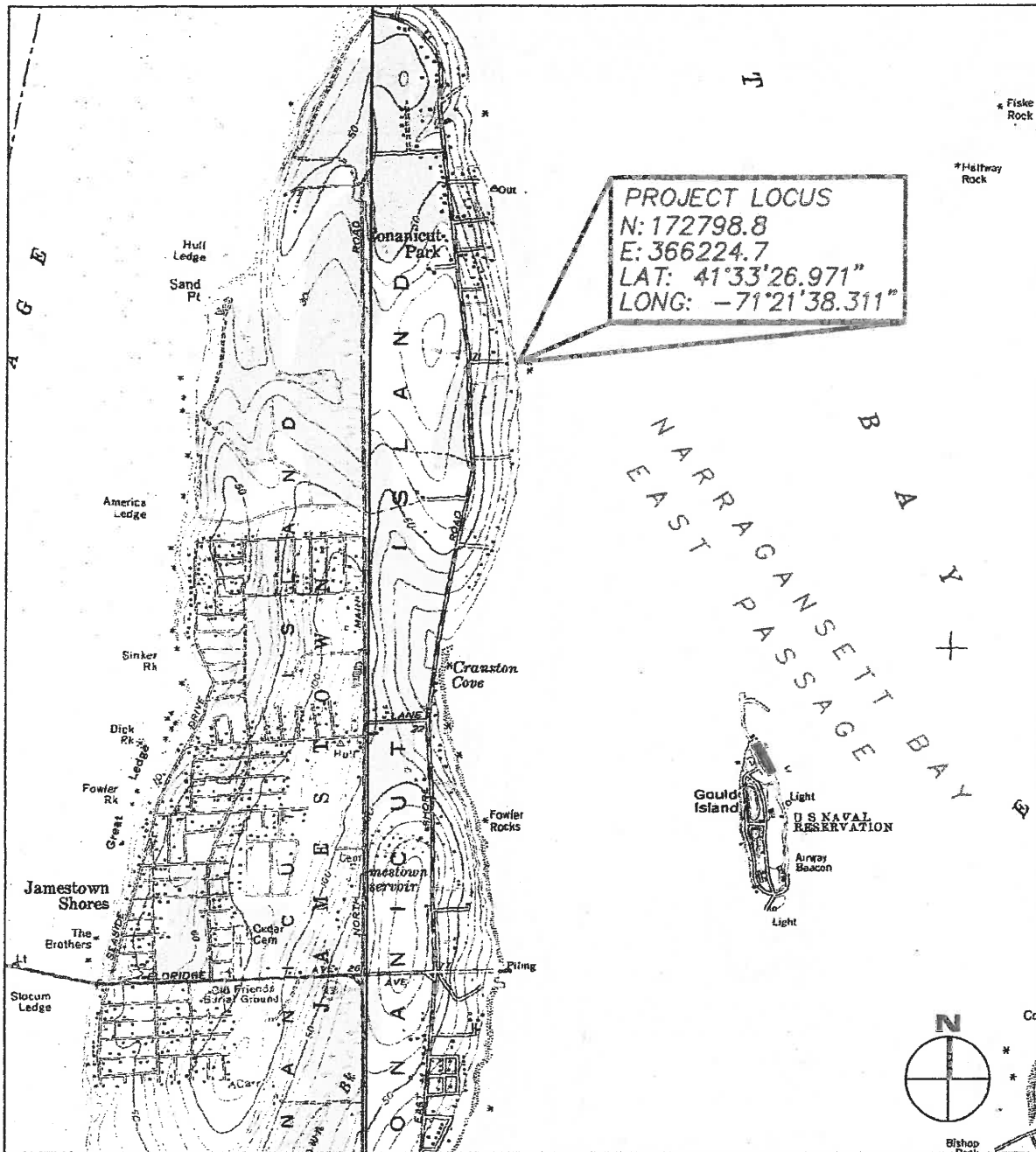

PROJECT LOCUS
 N: 172798.8
 E: 366224.7
 LAT: 41°33'26.971"
 LONG: -71°21'38.311"

LOCUS PLAN

PROPOSED RESIDENTIAL SAV PIER FOR:
 TONY ABBIATI
 AP 2, LOT 95
 38 COLLINS TERRACE
 JAMESTOWN, RI 02835
 BY: WARREN HALL, CIVIL ENGINEER
 OCTOBER 31, 2018 SHEET 1 OF 6



RECEIVED
 DEC 10 2018
 COASTAL RESOURCES
 MANAGEMENT COUNCIL

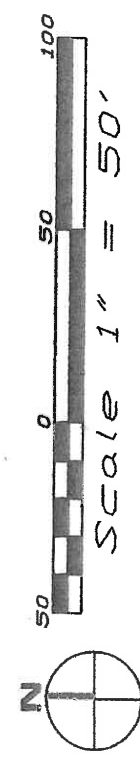

SAV TRANSECT LOCATIONS

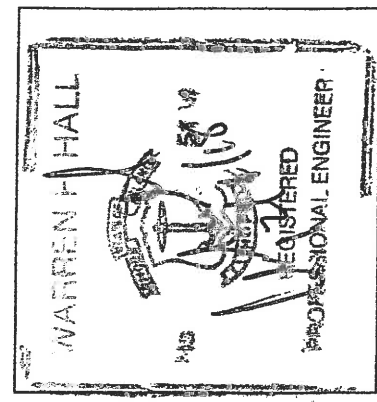
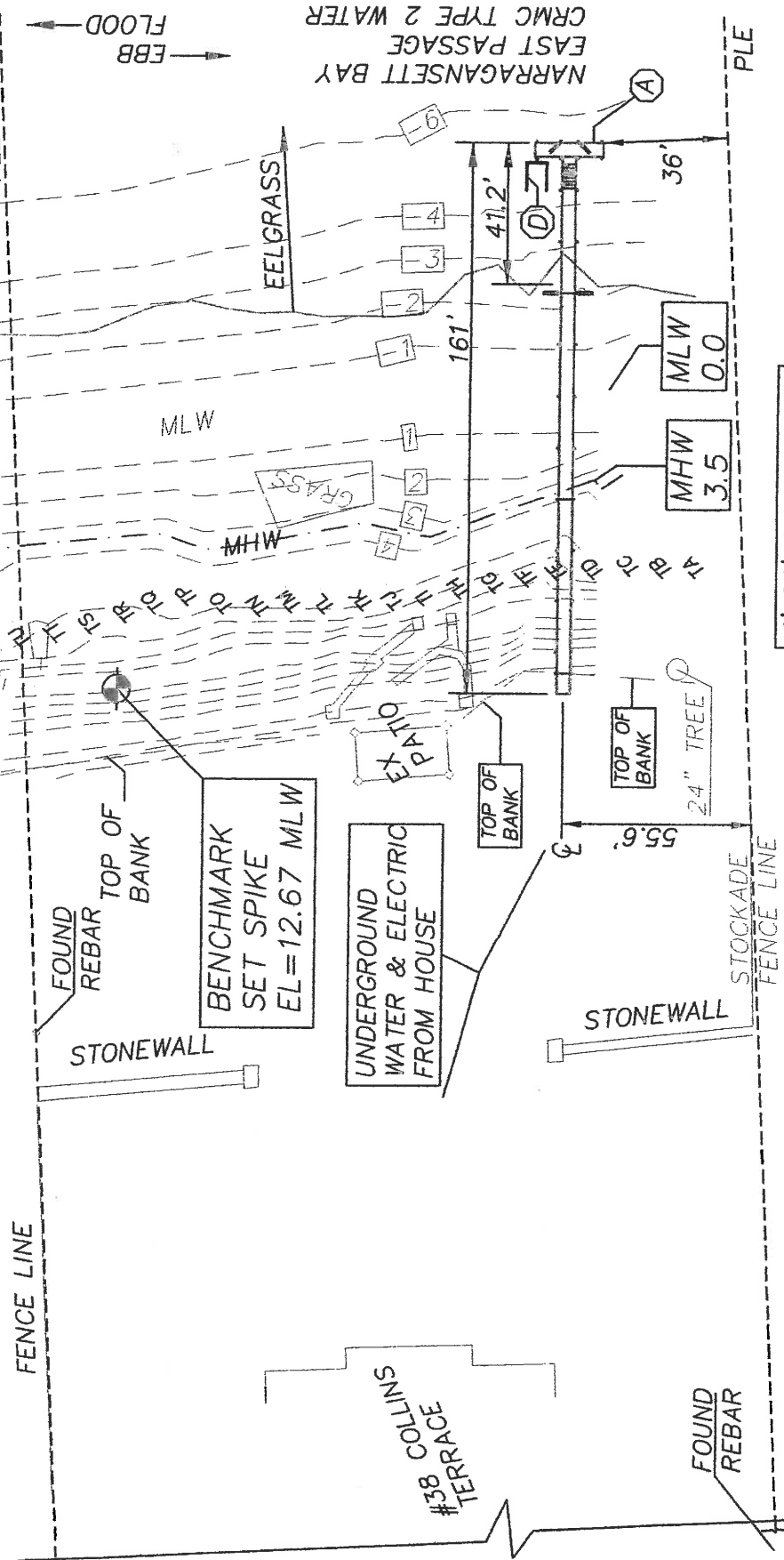

PROPOSED RESIDENTIAL SAV PIER FOR:
 TONY ABBIATI
 AP 2, LOT 95
 38 COLLINS TERRACE
 JAMESTOWN, RI 02835
 BY: WARREN HALL, CIVIL ENGINEER
 OCTOBER 31, 2018 SHEET 2 OF 6

- LEGEND**
- PLE PROPERTY LINE EXTENSION
 - MLW MEAN LOW WATER
 - MHW MEAN HIGH WATER
 - EELGRASS
 - EELGRASS TRANSECT (FIELD LOCATED)

PLAN VIEW PROPOSED PIER
 NOT A BOUNDARY SURVEY

- (A) 4'x20' ACCESS PIER DECK EL=6.5
- (D) 1200# BOAT LIFT

NARRAGANSETT BAY
 EAST PASSAGE
 CRMC TYPE 2 WATER

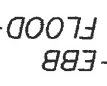

FENCE LINE

PLE

STOCKADE FENCE LINE

#38 COLLINS TERRACE

EELGRASS

MLW

MHW

UNDERGROUND WATER & ELECTRIC FROM HOUSE

BENCHMARK SET SPIKE EL=12.67 MLW

FOUND REBAR TOP OF BANK

STONEWALL

STONEWALL

TOP OF BANK 24" TREE

TOP OF BANK

MLW 0.0

MHW 3.5

161'

41.2'

36'

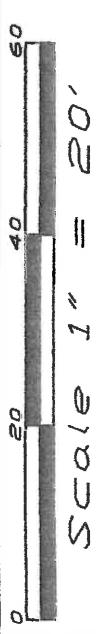

RI STATE PLANE COORDINATES

N: 172798.8
E: 366222.6

TIDAL DATUM REFERENCE NEWPORT

N: 172808.8
E: 366377.7

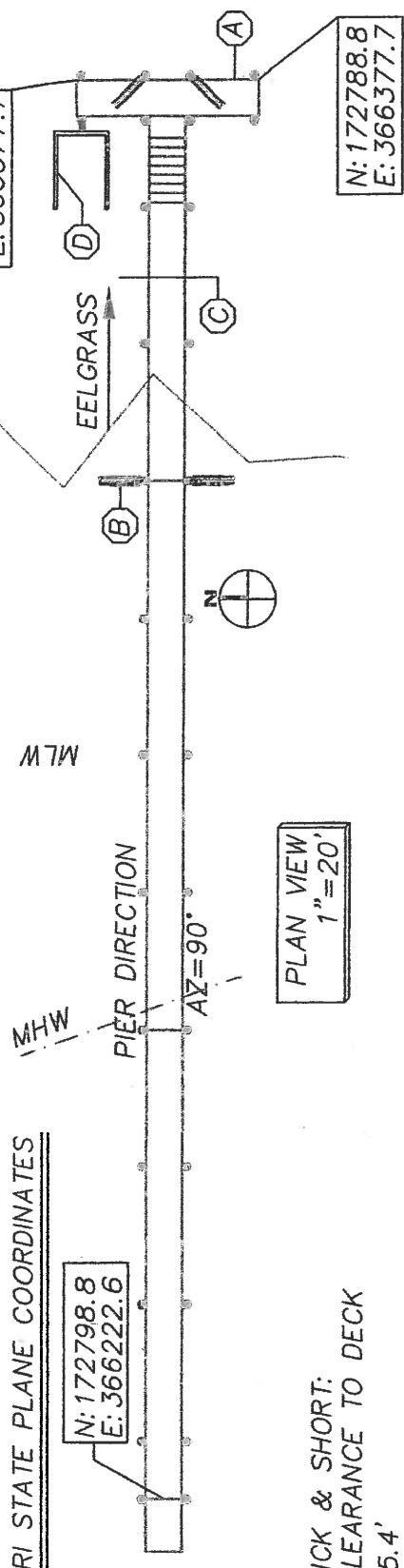

PER BURDICK & SHORT:
BOTTOM CLEARANCE TO DECK
AZ=90°; 15.4'
AZ=0°; 10.1'

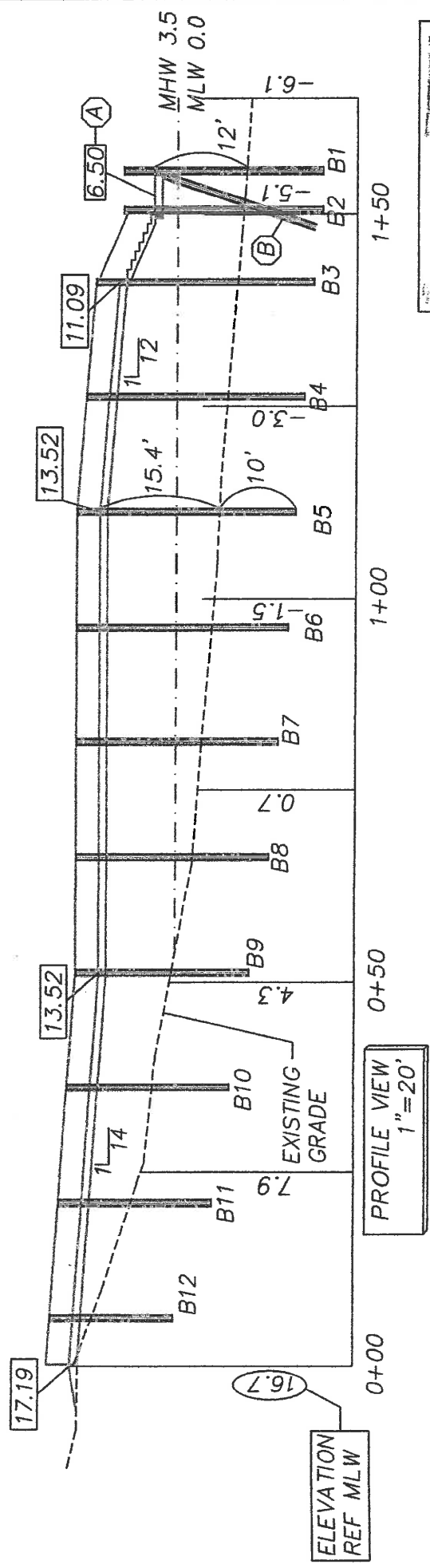

ELEVATION REF MLW

(A) 4'x20' ACCESS PIER
DECK EL=6.5

(B) BATTER PILES

(C) TYPICAL CROSS SECTION
SEE SHEET 4 & 5

(D) 1200# BOAT LIFT

PROPOSED RESIDENTIAL SAV PIER FOR:
TONY ABBIATI
AP 2, LOT 95
38 COLLINS TERRACE
JAMESTOWN, RI 02835
BY: WARREN HALL, CIVIL ENGINEER
OCTOBER 31, 2018 SHEET 3 OF 6

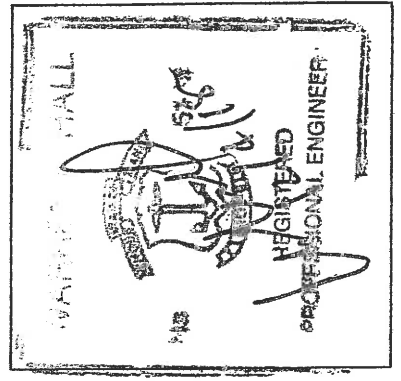

RECEIVED
DEC 10 2018
COASTAL RESOURCES
MANAGEMENT COUNCIL



State of Rhode Island and Providence Plantations
Coastal Resources Management Council
 Oliver H. Stedman Government Center
 4808 Tower Hill Road, Suite 3
 Wakefield, RI 02879-1900

(401) 783-3370
 Fax (401) 783-2069

PUBLIC NOTICE

File Number: 2018-10-108 Date: January 2, 2019

This office has under consideration the application of:

William C. and Virginia R. Prichett
 19 Bridge View Drive
 Jamestown, RI 02835

for a State of Rhode Island Assent to construct and maintain:

a residential boating facility over eelgrass with a 1200lb tender lift extending 179.2' beyond mean low water (MLW) to a water depth of -5' MLW.

Project Location:	19 Bridge View Drive
City/Town:	Jamestown
Plat/Lot:	2 / 82
Waterway:	East Passage of Narragansett Bay

Plans of the proposed work may be seen at the CRMC office in Wakefield.

In accordance with the Administrative Procedures Act (Chapter 42-35 of the Rhode Island General Laws) you may request a hearing on this matter.

You are advised that if you have good reason to enter protests against the proposed work it is your privilege to do so. It is expected that objectors will review the application and plans thoroughly, visit site of proposed work if necessary, to familiarize themselves with the conditions and cite what law or laws, if any, would in their opinion be violated by the work proposed.

If you desire to protest, you must attend the scheduled hearing and give sworn testimony. A notice of the time and place of such hearing will be furnished you as soon as possible after receipt of your request for hearing. If you desire to request a hearing, to receive consideration, it should be in writing (**with your correct mailing address, e-mail address and valid contact number**) and be received at this office on or before February 2, 2019.

/lat

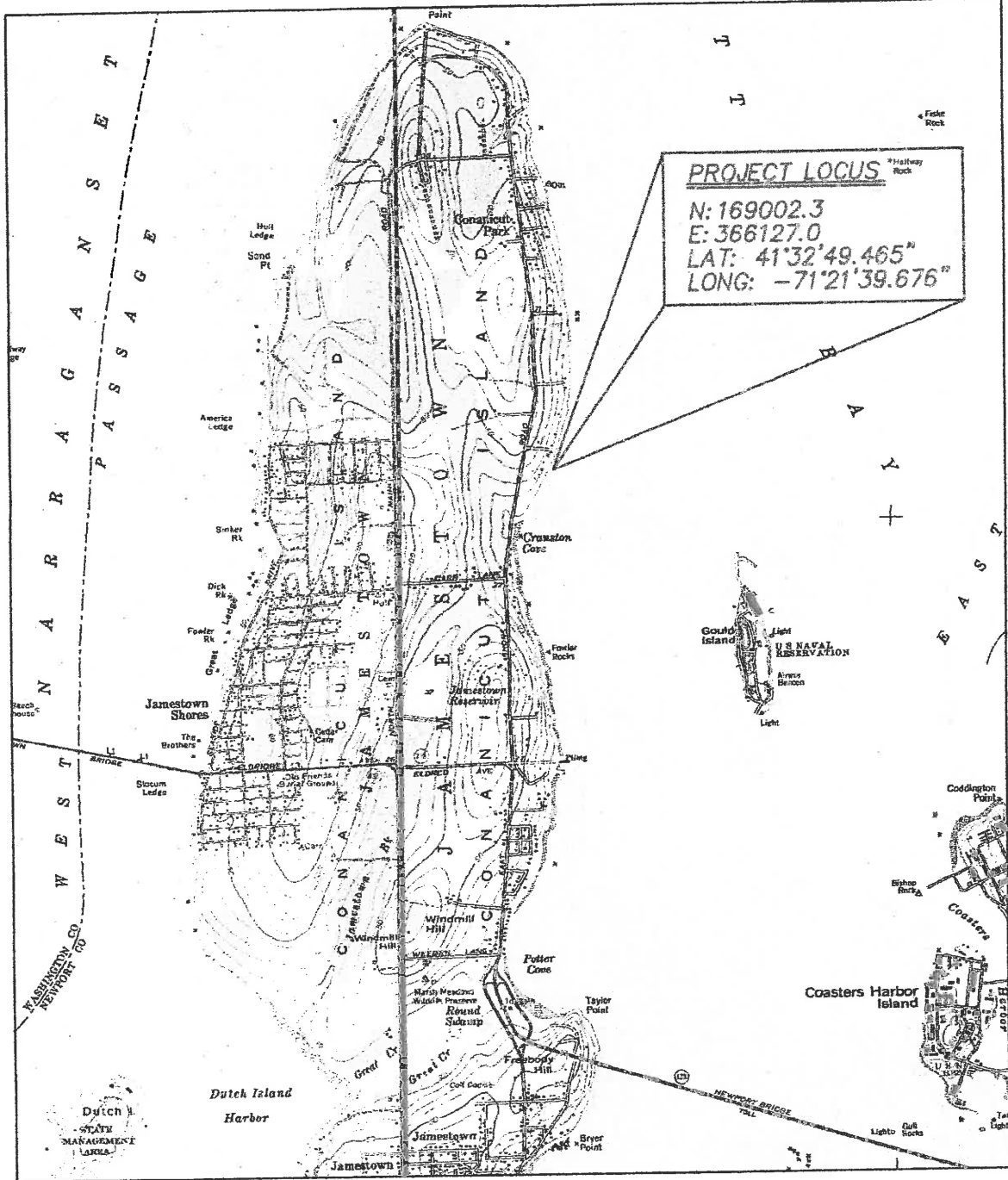

PROPOSED RESIDENTIAL SAV PIER FOR:
 WILLIAM PRICHETT
 19 BRIDGE VIEW DRIVE, JAMESTOWN, RI 02835
 AP 2, LOT 82
 BY: WARREN HALL, CIVIL ENGINEER
 SEPTEMBER 28, 2018 SHEET 1 OF 6

WARREN F. HALL

REGISTERED PROFESSIONAL ENGINEER

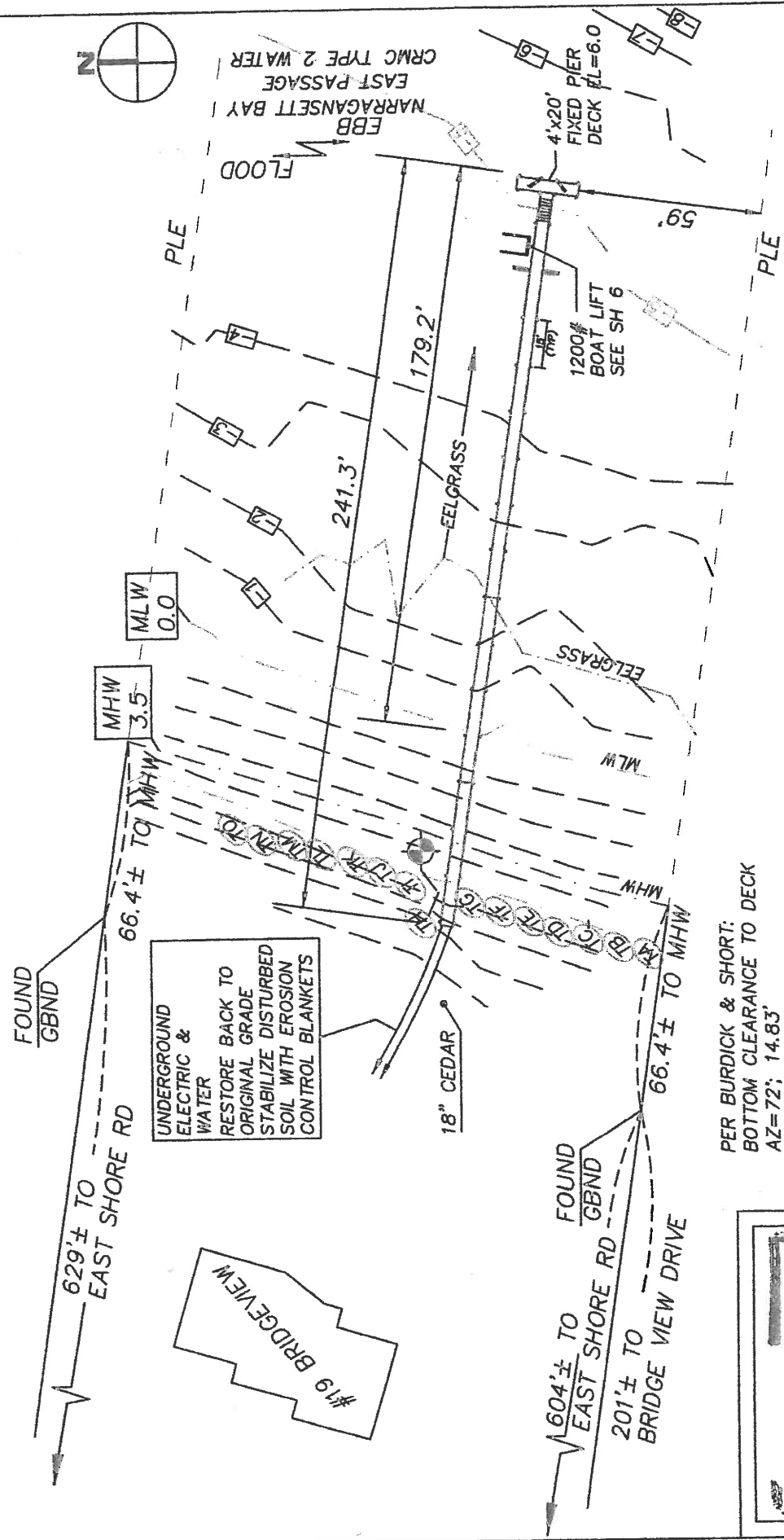
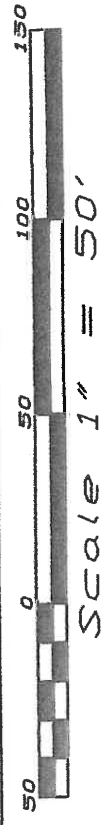

- LEGEND**
- PLE PROPERTY LINE EXTENSION
 - MLW MEAN LOW WATER
 - MHW MEAN HIGH WATER
 - EELGRASS

(TA) EELGRASS TRANSECT (FIELD LOCATED)
 (SEE SAV STUDY BY NRS DATED 8-31-18)
 RISPC RHODE ISLAND STATE PLANE COORDINATES

PER BURDICK & SHORT:
 BOTTOM CLEARANCE TO DECK
 AZ=72'; 14.83'
 AZ=8'; 10.6'

BENCHMARK: SET SPIKE
 EL=3.29 MLW

PROPOSED RESIDENTIAL SAV PIER FOR:
 WILLIAM PRICHETT
 19 BRIDGE VIEW DRIVE, JAMESTOWN, RI 02835
 AP 2, LOT 82
 BY: WARREN HALL, CIVIL ENGINEER
 SEPTEMBER 28, 2018 SHEET 2 OF 6

WARREN HALL

REGISTERED
 PROFESSIONAL ENGINEER

TIDAL DATUM REFERENCE NEWPORT

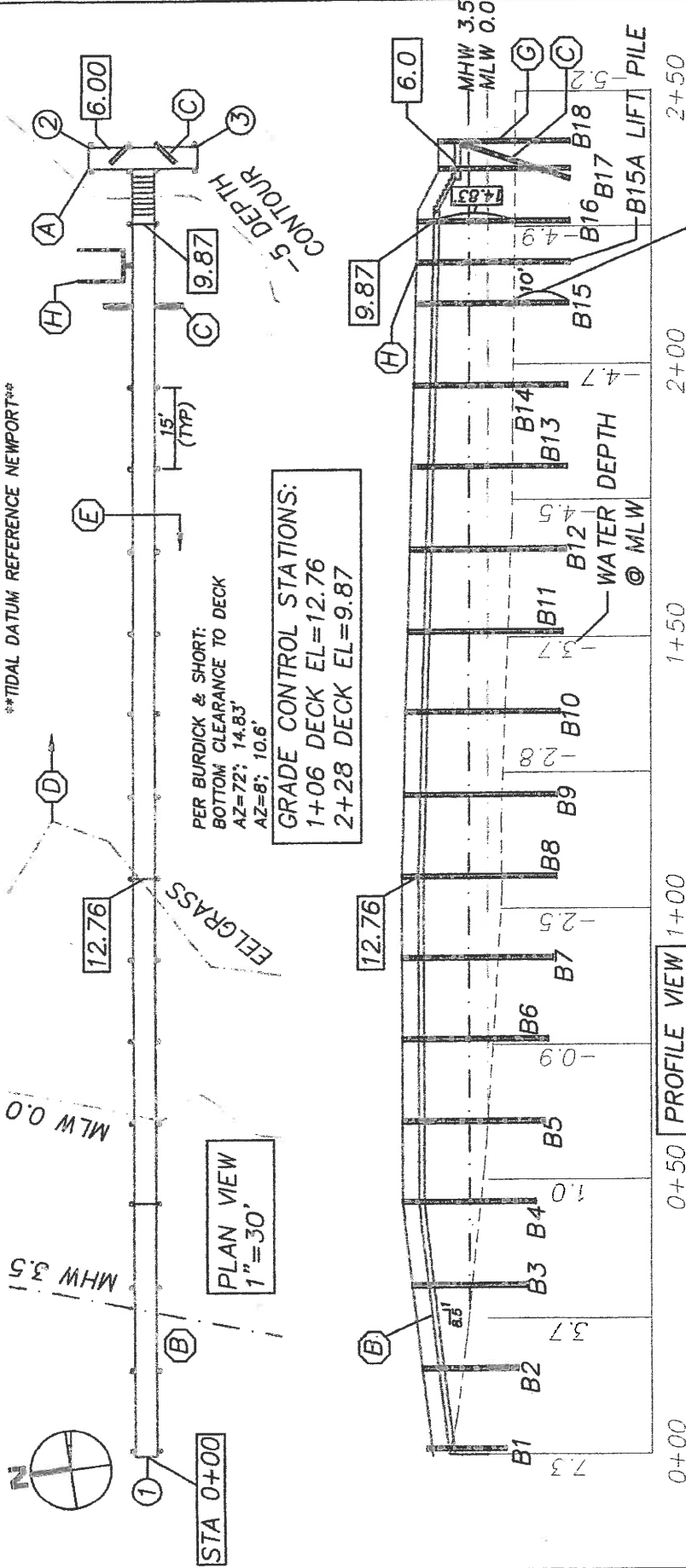

PER BURDICK & SHORT:
 BOTTOM CLEARANCE TO DECK
 AZ=72; 14.83'
 AZ=8; 10.6'

GRADE CONTROL STATIONS:
 1+06 DECK EL=12.76
 2+28 DECK EL=9.87

DRIVE ALL PILES TO MINIMUM 10' EMBEDMENT
 CONTRACTOR TO KEEP RECORD OF ALL PILE
 LENGTHS, CUT OFF LENGTHS & LOCATION
 RECORD TO BE USED FOR EMBEDMENT

1200# BOAT LIFT, RESTRICTED TO
 BOATS NO GREATER THAN 12' IN
 LENGTH & 1200# IN WEIGHT
 STOPS TO BE INSTALLED
 PREVENTING GUNWALE OF
 RAISED BOAT TO BE NO HIGHER
 THAN ELEVATION 9.87 SEE SH 6

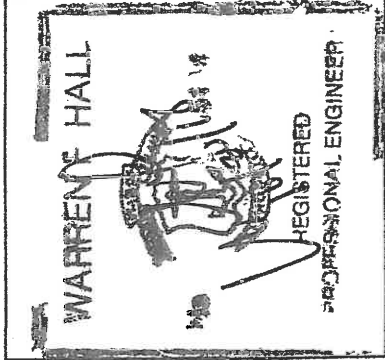

- (A) 4'x20' ACCESS PIER
DECK EL=6.0'
- (B) RAMP
8.5H:1V
- (C) BATTER PILES
- (D) EELGRASS BED
- (E) SEE SHEET 4 & 5
- (F) 7R@6.5"
6T@12"
- (G) GROSS BRACE FIXED
ACCESS PIER IN ALL
DIRECTIONS
- (H)

PROPOSED RESIDENTIAL SAV PIER FOR:
 WILLIAM PRICHETT
 19 BRIDGE VIEW DRIVE, JAMESTOWN, RI 02835
 AP 2, LOT 82
 BY: WARREN HALL, CIVIL ENGINEER
 SEPTEMBER 28, 2018 SHEET 3 OF 6

RISPC

- (1) N: 169002.3
E: 366127.0
- (2) N: 168977.3
E: 366366.2
- (3) N: 168957.5
E: 366363.3



Scale 1" = 30'



SAVE THE BAY®

NARRAGANSETT BAY

December 13, 2018

Andy Nota
Town Administrator
93 Narragansett Ave, 2nd Floor
Jamestown, RI 02835

Dear Andy Nota:

As a coastal community you know the importance of the rights guaranteed in the Rhode Island Constitution to use and enjoy the “privileges of the shore... including but not limited to fishing from the shore, the gathering of seaweed, leaving the shore to swim in the sea and passage along the shore;...”

As the agency charged with establishing public rights-of-way through a formal designation process (ROW), the Coastal Resources Management Council (CRMC)) works to ensure that the public has a way to get to the shore and enjoy our constitutional benefits. CRMC’s goal is to designate at least one right-of-way every mile along our 384 miles of shoreline. Public access is also core to Save The Bay’s (STB’s) mission and one of its major priorities. Since its inception, STB has been dedicated to preserving and creating lateral access along the shoreline while instilling a sense of ownership and stewardship for those who use the Bay. Recently, through a partnership with the CRMC, along with a cohort of partners and volunteers, STB completed a project that combined and corrected the existing geographic information system (GIS) designated rights-of-way (ROW) datasets. STB and CRMC also visited the 226 ROW and STB synthesized the GIS data and prepared a report summarizing the conditions of each site. The report found as follows:

- * More than half of the ROW are in need of maintenance.
- * More than one- third of the ROW are at least partly obstructed to foot traffic. Vegetation overgrowth and property encroachment were the most common obstructions while purposeful obstruction (placement of boulders, fences, gates, etc.) was observed at nine sites.
- * Only half of the ROW provide parking. Without public parking most citizens are unable to use the ROW, rendering the access obsolete.
- * Litter was observed at more than a third of the ROW, with fishing debris accounting for about half of the litter. Only 31 (of 226) ROW had trash receptacles, 11 had recycling receptacles.
- * Coastal flooding, coastal erosion and stormwater erosion were each observed at more than one third of the ROWs.

The need to ensure that existing ROW are maintained and available for public use has become increasingly important given development pressures and the impacts on existing

ROW from sea level rise, increased storm frequency and intensity, erosion, and hardening of the shoreline. Currently, about 133 miles of Narragansett Bay's shoreline is lined with riprap walls, bulkheads, and other manmade structures.

CRMC and STB are asking you to review the attached findings from the report related to your community and take all possible steps to preserve coastal access for all Rhode Islanders. Specifically, we requesting that you take the following steps:

- *Clear vegetation overgrowth to allow foot access over the designated ROWs in your community.

- * Plan for and create parking (or bike racks where parking is not feasible) so the ROWs may be enjoyed as intended. Amend current ordinances that prohibit parking at CRMC designated ROWs and remove no parking signs if it is possible to safely allow parking on the side of the road.

- * Supply trash and recycling receptacles that are fixed and locked with restricted-sized openings to prevent misuse and properly dispose of collected waste as needed.

- * Promote CRMC's successful Adopt an Access Program whereby neighborhood groups and organizations agree to be responsible for maintenance and trash removal at ROWs.

- * Work with CRMC and STB to establish additional ROWs. Designating additional ROWs is critical.

Please contact Kevin Cute at (401) 783-3370 for additional information and/or assistance in preserving and establishing rights-of-way to the shore. Thank you.

Sincerely,

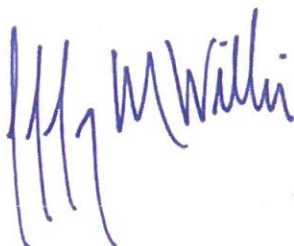

Jeff Willis
Deputy Director
RI Coastal Resources Management Council



Jonathan Stone
Executive Director
Save The Bay

RECEIVED
TOWN OF JAMESTOWN, R.I.

18 DEC 26 AM 11:09

216 West Reach Dr.
Jamestown, RI 02835
Dec. 21, 2018

To the Town Council Members -

Please take under consideration my request. I never pay my taxes late and made out a check for Dec. and March on Nov. 20 so I wouldn't forget the last payment. Since it was too early to drop it off (I am too thrifty to use a stamp!) I put it aside to drop it off in December.

I am 81 years old and am getting a little forgetful and overwhelmed trying to maintain my home in Jamestown. Since my husband died 21 years ago, I realized Weds., Dec. 19, that it was the last day of the 7 day grace period. Deciding it was too late and dash for me to drive to the drop box that night, I assumed if I presented it first thing the next morning it would be considered as good as being taken out of the box first thing of the day. Much to my dismay, the Finance Director told me I had a fine for over \$150! That seems rather steep for one hour over. Extremely upset I told her I would talk to the Town Manager, Andy Nota. He did not call me directly but asked the Finance Director to call me. She suggested I write a letter to the Town Council however in her 19 years they

(over)

never changed her ultimatum. If the fine had been about \$25, I would not have complained as it would be like a returned check. I felt \$150 was exorbitant.

Since I go to Florida for a few months in the winter I will not be there when you discuss it. I would greatly appreciate your doing whatever you can to alleviate this situation.

Looking forward to your support in this matter. My phone number is 401-423-1114.

Sincerely,

Constance P. Ramee



RHODE ISLAND LEAGUE OF CITIES AND TOWNS

Convention 2019

Join us for the 2019 Convention of the Rhode Island League of Cities and Towns.

When

Thursday, January 24, 2019

8:30 AM to 4:00 PM EST

 [Add to Calendar](#)

Where

The Crowne Plaza Hotel
801 Greenwich Ave
Warwick, RI 02886

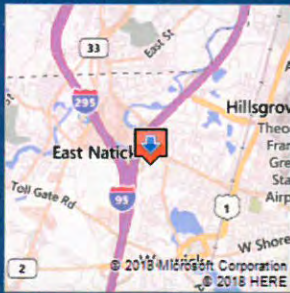

[Driving Directions](#)

Contact

Denise Arrighi
Rhode Island League of Cities & Towns
401-272-3434



More Event Details

Event is free of charge and open to municipal employees throughout Rhode Island.

Featured workshop topics include:

- Leadership for Public Officials
- Best Practices for Government Efficiency, including Lean Government
- Municipal Finance, including Capital Finance, Property Tax Assessment and Motor Vehicle Phase-Out
- Human Resources, including Grievance Arbitration and Disability Pensions
- Infrastructure, including Climate Change Resilience and IT Connectivity
- Zoning & Land Use, including Solar Siting, Short-Term Rentals, Housing, Public Recreation
- School Construction & Renovation
- Cybersecurity
- Census 2020
- Rhode Island Energy Aggregation Program (REAP)

[Register Now!](#)



RHODE ISLAND LEAGUE OF CITIES AND TOWNS

When

Thursday, January 24, 2019 from 8:30 AM to 4:00 PM EST

[Add to Calendar](#)

Where

The Crowne Plaza Hotel
801 Greenwich Ave
Warwick, RI 02886

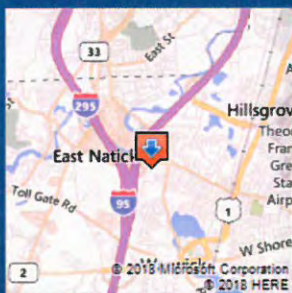

[Driving Directions](#)

Contact

Denise Arrighi
Rhode Island League of Cities & Towns
401-272-3434

Rhode Island League of Cities & Towns Convention 2019

Workshop topics include: • LEAN Government • Census 2020 • Tax Increment Financing • School Construction Update • Climate Change Risk • Grievance Arbitration • Solar Siting • Healthy Housing • Capital Finance Methods • Leadership models for Public Officials • Municipal Recreation

* Required information

Personal Information

* First Name:

* Last Name:

* Email Address:

* Confirm Email Address:

Business Information

* City:

Company:

* Job Title:

Department:

* I'm not a robot 
reCAPTCHA
Privacy - Terms

Join our list

By checking this box, you're consenting to receive marketing emails from:
Rhode Island League of Cities & Towns, 1 State Street - Suite 502, Providence, RI 02908, United States
<http://www.rileague.org>
You can revoke your consent to receive emails at any time by using the SafeUnsubscribe™ link, found at the bottom of every email. **Emails are serviced by Constant Contact.**

[Register](#)

[Go back to Event Page](#)